

**USER MANUAL
AUTO KERATO-REFRACTOMETER**

KR-1

INTRODUCTION

Thank you for purchasing the TOPCON Auto Kerato-Refractometer KR-1.

INTENDED USE / INDICATIONS FOR USE

This instrument is used to measure the spherical refractive-power, cylindrical refractive power, the direction of astigmatic axis, the radius of curvature, the corneal astigmatic axis angle and the corneal refractory power.

This instrument features the following:

- The KR-1 is simple to operate and measures the refraction and corneal curvature of the eye.
- The position of the touch panel can be adjusted to accommodate the user's preferred position.
- The auto start function facilitates quick measurements under the optimal condition.

This User Manual provides an overview of the basic operation, troubleshooting, checking, maintenance and cleaning of the TOPCON Auto Kerato-Refractometer KR-1.

To get the best use of the instrument, read Safety Displays and Safety Cautions.

Keep this Manual at hand for future reference.

PRECAUTIONS

- The patient who undergoes an examination by this instrument must maintain concentration for a few minutes and keep to the following instructions:
 - To fix the face to the chinrest, forehead rest.
 - To keep the eye open.
 - To understand and follow instructions when undergoing an examination.
- Since this product is a precision instrument, always use and keep it in a normally controlled living environment, within a temperature range of 10-40°C, humidity levels between 30-90% and an atmospheric pressure range of 700hPa-1,060hPa.
 - The instrument should also be placed away from direct sunlight.
- To ensure smooth operation, install the instrument on a level floor free of vibrations. Also, do not place anything on the instrument.
- Connect all cables properly before using.
- Use the power at a rated voltage.
- When not in use, switch off the power source and apply the rubber cap and dust cover.
- For accurate measurement results, take care to keep the measuring window clean and free of fingerprints, spots and dust.

[WARNING] When operating the instrument, do not touch the patient's eye or nose.



This symbol is applicable for EU member countries only.
To avoid potential damage to the environment and possibly human health, this instrument should be disposed of (i) for EU member countries - in accordance with WEEE (Directive on Waste Electrical and Electronic Equipment), or (ii) for all other countries, in accordance with local disposal and recycling laws.

[WARNING]

Handling the cord on this product or cords associated with accessories sold with this product, will expose you to lead, a chemical known to the State of California to cause birth defects or other reproductive harm. **Wash hands after handling.**

This product contains a CRL Lithium Battery which contains Perchlorate Material-special handling may apply. See <http://www.dtsc.ca.gov/hazardouswaste/perchlorate/>
Note: This is applicable to California, U.S.A. only

Since this product partly uses a program derived from IPA Font, using the product is regarded as consent to the IPA Font License Agreement v1.0.

For the IPA Font License Agreement v1.0, see page 68 or the following URL.
http://ipafont.ipa.go.jp/ipa_font_license_v1.html



0123

PRECAUTIONS

BASIC INSTRUCTIONS

- To avoid injury when operating the chinrest up/down button, be careful not to catch the patient's fingers.
- To avoid injury when operating the instrument, be careful not to touch the eye/nose of the patient.
- To avoid injury by electric shock, do not open the cover. For repair, call your service engineer.
- To avoid injury by electric shock when changing the fuse, turn off the power and pull off the power cable. Use the rated fuse.

DISPOSAL

When disposing of the instrument and/or parts, follow local regulations for disposal and recycling.

STORAGE AND USAGE PERIOD

1. WHEN STORING THE INSTRUMENT, ENSURE THAT THE FOLLOWING CONDITIONS ARE MET:

- (1) The instrument should not be splashed with water.
- (2) Store the instrument away from environments where air pressure, temperature, humidity, ventilation, sunlight, dust, salty/sulfurous air, etc. could cause damage.
- (3) Do not store or transport the instrument on a slanted or uneven surface or in an area where it is subject to vibrations or instability.
- (4) Do not store the instrument where chemicals are stored or gas is generated.

2. NORMAL LIFE SPAN OF THE INSTRUMENT:

8 years from delivery providing regular maintenance is performed (according to the self-certification [Topcon data])

USER MAINTENANCE

1. Regularly measure the attached model eye and check the accuracy.
2. Clean the measuring window when it is soiled.
3. Clean the forehead rest and chinrest when these are soiled.
4. Put on the dust cover when not in use.

HOW TO READ THIS MANUAL

- Read the instructions on pages 1 to 8 before using the machine.
- Regarding connection to various devices, see "CONNECTING EXTERNAL I/O TERMINALS" on page 20.
- If you would like an overview of the system, begin by reading "BASIC OPERATIONS"(page 24).
- For setting various functions, see "SETTING FUNCTIONS ON SETUP SCREEN" on page 44.

SYMBOLS IN TEXT





MEMO: Useful functions to know and attentions to prevent troubles are noted.

SAFETY DISPLAYS







In order to encourage the safe use of the instrument and to avoid danger to the operator and others as well as damage to properties, warnings are described in the User Manual and marked on the instrument body.

We suggest you thoroughly understand the meaning of the following displays/icons and Safety Cautions, as well as read the Manual, and strictly observe the instructions.

DISPLAYS









DISPLAY	MEANING
 WARNING	Improper handling or ignoring this display may lead to the danger of death or serious injury.
 CAUTION	Improper handling or ignoring this display may cause personal injury or physical damage.
<ul style="list-style-type: none">• Injury means hurt, burn, electric shock, etc.• Physical damage means extensive damage that may involve building, peripheral equipment and furniture.	

ICON

ICON	MEANING
	This icon indicates an action to be avoided. Specific contents are shown with words or illustration close to the  icon.
	This icon indicates Mandatory Action. Specific contents are shown with words or illustration close to the  icon.
	This icon indicates Hazard Alerting (Warning). Specific content are shown with words or illustration close to the  icon.

SAFETY CAUTIONS













!	WARNINGS
---	----------

Icon	Meaning	Page
	To avoid electrical shock, do not open the instrument. All service should be performed by a qualified service engineer.	55
	To avoid fire and electric shock, install the instrument in a dry place free of water and other liquids.	—
	To avoid fire and electric shock, do not put cups or other containers with liquids near the instrument.	—
	To avoid electric shocks, do not insert metal objects into the instrument body through the vent holes or gaps.	—
	Be sure to connect the power plug to an AC 3-pin receptacle equipped with grounding. Connection with receptacle without grounding may cause fire and electric shock in case of short-circuiting.	19
	To avoid electric shocks during fuse change, be sure to unplug the power cable before removing the fuse lid. Also, do not plug the power cable with the fuse lid removed.	68
	Always use the attached fuse (T 3AL 250V). Using any other type may cause malfunction and fire.	68
	To avoid fire in the event of an instrument malfunction, immediately turn OFF the power switch "○" and disconnect the power plug from the outlet if you see smoke coming from the instrument, etc. Don't install the instrument where it is difficult to disconnect the power plug from the outlet. Ask your dealer for service.	—

SAFETY CAUTIONS



CAUTIONS

Icon	Meaning	Page
	To prevent damage and injuries, do not install the instrument on an uneven, unsteady or sloped surface.	19
	To avoid electric shocks, do not handle the power plug with wet fingers.	19
	To avoid electric shock, do not touch the external connection terminal and the patient at the same time.	20 25
	To avoid injury when moving the chinrest up/down button, be careful not to catch the patient's fingers.	25
	To avoid injury when operating the machine, be careful about the cover not to catch fingers of the patient. Tell this to the patient, too.	25
	To avoid failure or potential injury, do not open the printer cover while the printer is in operation.	21 67
	To avoid potential injury in case of malfunction including a paper jam, be sure to shut off the power before attempting to repair it.	21 67
	The instrument should be moved by two people holding the bottom of the device. Be sure to hold the bottom with two persons. To avoid injury, be aware of projections at the bottom. Carrying by one person may cause harm to his back or injury by falling parts. Also, holding areas other than the bottom and holding the External I/O terminal cover may cause injury, as well as damage to the instrument.	19
	Be careful not to hit the patient's eyes or nose with the instrument during operation.	8
	When setting an instrument on an instrument table, pay attention not to catch the patient's fingers between the instrument and the table.	19
	To avoid potential injury, do not touch the printer body including metal parts or the paper cutter, while the printer is in operation or when replacing the printer paper.	21 67
	This instrument has been tested (with 100/120/230V) and found to comply with IEC60601-1-2:Ed.3.0:2007. This instrument radiates radio frequency energy within standard and may affect other devices in the vicinity. If you have discovered that turning on/off the instrument affects other devices, we recommend you change its position, keep a proper distance from other devices, or plug it into a different outlet. Please consult your authorized dealer if you have any additional questions.	—

USAGE AND MAINTENANCE

Usage:

- Since the Auto Kerato-Refractometer KR-1 is medical device, the operation should be supervised by a physician.

USER MAINTENANCE

To maintain the safety and performance of the equipment, never attempt to do maintenance except for the items specified below. For details, follow the instructions.

FUSE CHANGE

For details, See “FUSE CHANGE” on page 68.

CLEANING OF MEASURING WINDOW

For details, See “CLEANING THE INSTRUMENT” on page 65.

DISCLAIMERS

- TOPCON is not responsible for damage due to fire, earthquakes, actions or inactions of third persons or other accidents, or damage due to negligence and misuse by the user and any use under unusual conditions.
- TOPCON is not responsible for damage derived from inability to properly use this equipment, such as loss of business profits and suspension of business.
- TOPCON is not responsible for damage caused by operations other than those described in this User Manual.
- The device does not provide a diagnosis of any condition or lack thereof or any recommendations for appropriate treatment. The relevant healthcare provider is fully responsible for all diagnosis and treatment decisions and recommendations.

WARNING LABEL POSITIONS

To secure safety, this equipment provides warnings.

Correctly use the equipment following these warning instructions. If any of the following marking labels are missing, please contact your dealer or TOPCON at the address stated on the back cover.

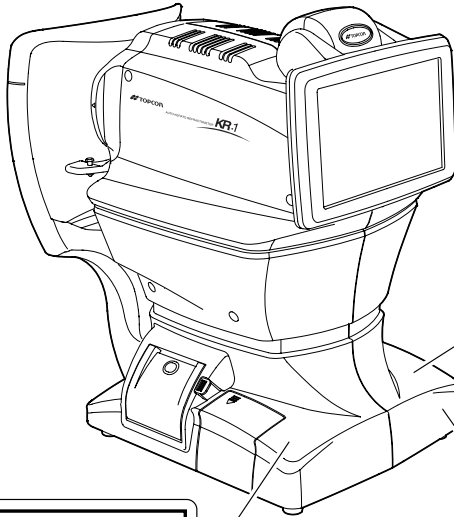

⚠ CAUTION
When operating the chinrest up/down switch, be careful not to pinch the patient's hand. The patient may be injured.

⚠ CAUTION
Be careful not to hit the patient's eyes or nose with the instrument during operation.

⚠ WARNING
To avoid injury caused by electric shock, do not open the cover. Ask your dealer for service.

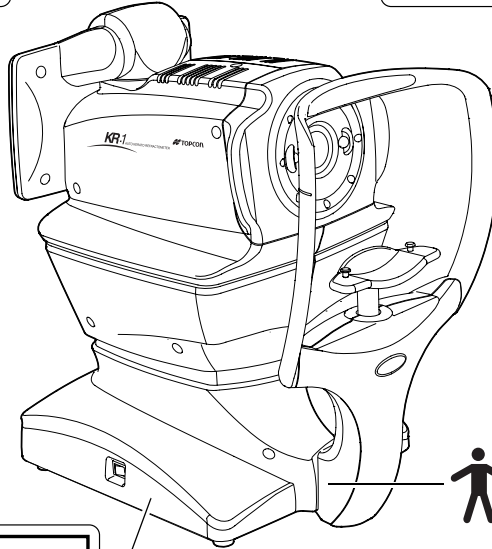

⚠ WARNING
Electric shock may cause burns or a possible fire. Turn the power switch OFF and unplug the power cord before replacing the fuses. Replace only with fuses of the correct rating.



Degree of protection against electric shock: TYPE B APPLIED PART

CONTENTS

INTRODUCTION	1
HOW TO READ THIS MANUAL	3
SYMBOLS IN TEXT	3
SAFETY DISPLAYS	4
DISPLAYS	4
ICON.....	4
SAFETY CAUTIONS	5
USAGE AND MAINTENANCE	7
USER MAINTENANCE.....	7
FUSE CHANGE.....	7
CLEANING OF MEASURING WINDOW.....	7
DISCLAIMERS	7
WARNING LABEL POSITIONS.....	8
COMPONENTS	
COMPONENT NAMES.....	11
COMPOSITION OF PARTS WHICH CONTACT THE HUMAN BODY	11
OPERATION METHOD OF CONTROL PANEL.....	12
CONTROL PANEL COMPONENTS.....	12
FUNCTION BUTTON	13
MONITOR SCREEN.....	14
MEASUREMENT SCREEN.....	14
SETTINGS SCREEN.....	14
CORNEA DIAMETER MEASUREMENT SCREEN.....	14
PRINTER OUTPUT	15
PRINTOUT FORMAT SETTING	17
STANDARD ACCESSORIES	18
PREPARATIONS	
INSTALLATION	19
CONNECTING POWER CABLE	19
CONNECTING EXTERNAL I/O TERMINALS	20
DATA OUTPUT	20
DATA INPUT	21
PRINTER PAPER SETTING	21
RECOVERY FROM POWER SAVE STATUS.....	23
ADJUSTING THE CONTROL PANEL POSITION.....	23
BASIC OPERATIONS	
PREPARATION BEFORE MEASUREMENT	24
TURNING ON THE INSTRUMENT	24
SELECTING THE MEASUREMENT MODE	24
PATIENT POSITIONING	25
AUTO MODE MEASUREMENT	27
SETTING THE AUTO MODE	27
ALIGNMENT AND MEASUREMENT	28
DISPLAYING MEASUREMENT VALUES	29
MANUAL MODE MEASUREMENT	30
SETTING THE MANUAL MODE	30
ALIGNMENT AND MEASUREMENT	30
DISPLAYING MEASUREMENT VALUES	33
PRINT-OUT OF MEASUREMENT VALUES	34
CLEARING MEASUREMENT VALUES	35
DISPLAYING ALL MEASUREMENT DATA	36
OPERATION OF AFTER USE	37

OPTIONAL OPERATIONS

DISPLAYING THE PATIENT ID (PATIENT NO.) OR EXAMINER ID	38
MEASURING ONE EYE ONLY	38
MEASURING THE RIGHT EYE ONLY	38
MEASURING THE LEFT EYE ONLY	38
MEASUREMENT OF CORNEA DIAMETER	39
MEASUREMENT ON THE ACTUAL IMAGE	39
MEASUREMENT ON THE STILL IMAGE	41
OUTPUT USING RS232C	43
INPUT USING USB	43
OUTPUT USING LAN	43

SETTING FUNCTIONS ON SETUP SCREEN

OPERATING THE SETUP SCREEN	44
PREPARATIONS FOR SETTING	44
OUTLINE OF SETUP SCREEN OPERATIONS	45
RETURNING TO THE MEASUREMENT SCREEN	47
LIST OF SETUP ITEMS	48
INITIAL (INITIAL SETTING)	48
SETTING OF INTERNAL PRINTER (PRINT)	50
DATA COMMUNICATION (COMM)	52
LAN CONNECTION (LAN)	53
OPERATOR ID	53
SPECIAL	53

TROUBLESHOOTING

MESSAGE LIST	54
TROUBLE-SHOOTING OPERATIONS	55

SPECIFICATIONS AND PERFORMANCE

SPECIFICATIONS AND PERFORMANCE	56
ENVIRONMENTAL CONDITIONS OF USE	57
ENVIRONMENTAL CONDITIONS OF STORAGE	57
ENVIRONMENTAL CONDITIONS OF TRANSPORT	57
ELECTROMAGNETIC COMPATIBILITY	58
ELECTRIC RATING	62
SAFETY DESIGNATIONS PER IEC 60601-1 STANDARD	62
DIMENSIONS AND WEIGHT	62
OPERATION AND PRINCIPLE OF OPERATION	63

REFERENCE

OPTIONAL ACCESSORIES	64
SHAPE OF PLUG	64
SYMBOL	64

MAINTENANCE

DAILY CHECKUPS	65
CHECKING THE MEASURING ACCURACY	65
CLEANING THE INSTRUMENT	65
CLEANING THE FOREHEAD REST AND CHIN REST	65
DAILY MAINTENANCE	66
ORDERING CONSUMABLE ITEMS	66
USER MAINTENANCE ITEM	66
BRIGHTNESS ADJUSTMENT OF CONTROL PANEL	67
PRINTER PAPER JAM	67
FUSE CHANGE	68
SUPPLYING THE CHINREST TISSUE	69
MAINTENANCE	70
CLEANING THE COVER	70
CLEANING THE CONTROL PANEL	70

COMPONENTS

COMPONENT NAMES

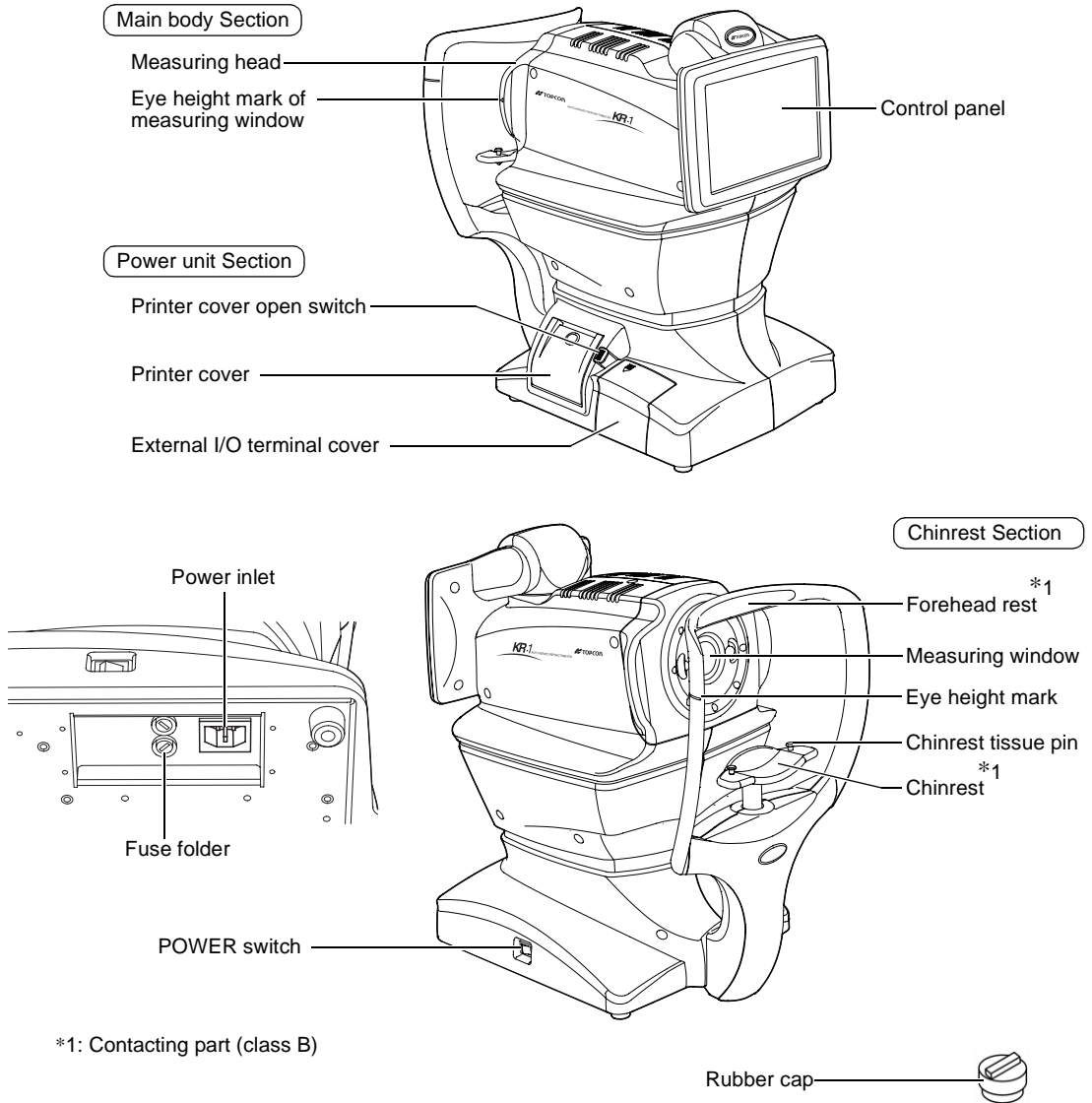

COMPOSITION OF PARTS WHICH CONTACT THE HUMAN BODY

- Forehead rest : Silicone rubber
- Chinrest : Acrylonitrile butadiene styrene resin

OPERATION METHOD OF CONTROL PANEL

NOTE: The control panel is a touch panel. Do not use any sharp tools; e.g. ball point pen.

Tap → To select any relevant item.

Continue to press → Used for continuous moving.
(Moving of chinrest and measuring head)

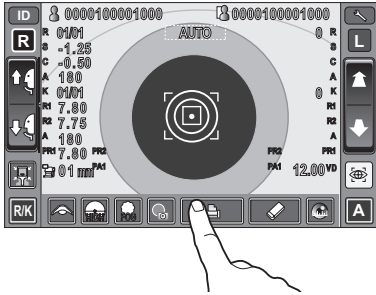

Touch the screen softly with a finger.

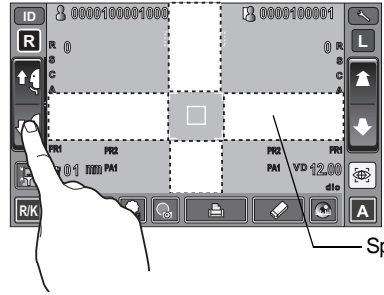

Continue to touch the screen softly with a finger. In the measurement screen, only a specified area can be operated.

CONTROL PANEL COMPONENTS

The control panel is designed as a touch panel for performing various operations and settings. It displays images and shows information, including set conditions and measurement results.

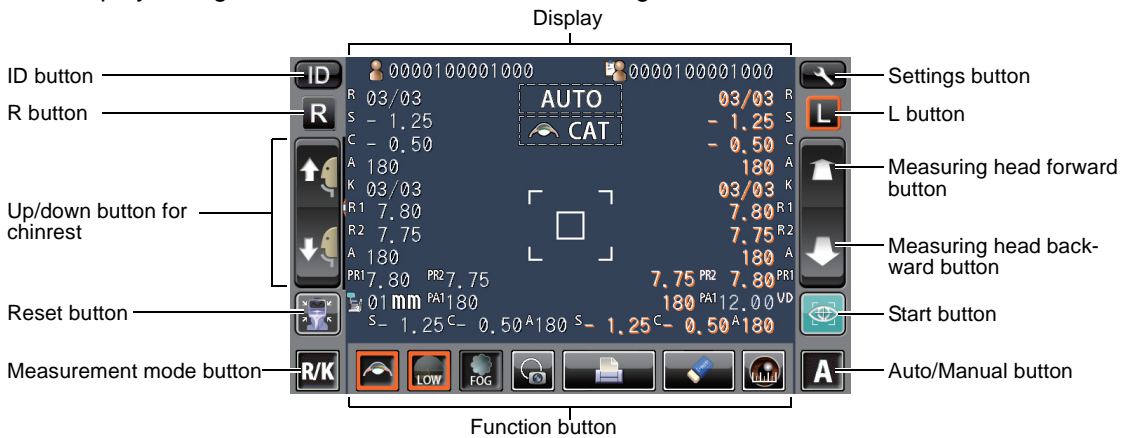

ID ID button Input the patient ID (up to 13 characters) and operator ID (up to 21 characters). However, if no patient ID is input, the patient No. is allocated automatically.

R/K Measurement mode button Selects a measurement mode from REF, KRT and R/K.

R L R button/L button..... Selects the right/left eye. By tapping the button, the main body moves to the selected direction. The selected button is framed in orange.



Up/down button for chinrest ... Moves the chinrest up/down.



Reset button Returns the chinrest and measuring head to the initial position.



Forward/backward button for measuring head Moves the measuring head closer to/away from the patient's eye.



Start button..... Starts measurement .



Auto/Manual button..... Selects Auto/Manual mode (A: Auto mode, M: Manual mode). The name of selected (Auto/Manual) is displayed on the control panel.



Settings button Displays the Settings screen.

FUNCTION BUTTON

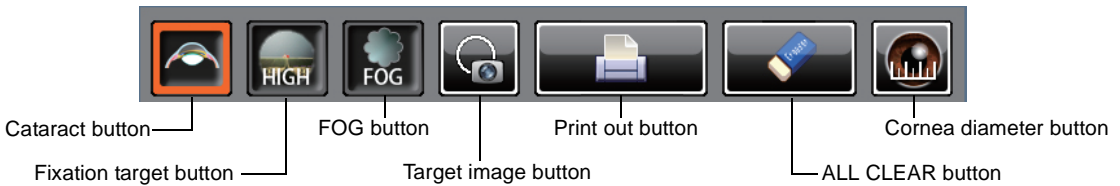

Cataract button..... If error messages occur in patient's with cataracts, push the Cataract button may improve measurements. When the button is selected, "CAT" is displayed on the monitor and the selected button is framed in orange.



Fixation target button Brightness of the fixation target can be changed. When the brightness of the fixation target is "LOW," the selected button is framed in orange.



FOG button Changes setting temporarily to perform fogging only in the first measurement or each time in the continuous measurement.



Target image button The captured measurement target can be observed on the control panel.



Print out button Prints measurement results. Tap the button when no measurement data is present to feed the paper. By setting the printer mode to Graphic Printer on the Settings screen, figures showing refractive conditions can be printed. In this case, the printer button changes to .



ALL CLEAR button..... Clears all measurement data.



Cornea diameter button .. Changes to cornea diameter measurement mode.

MONITOR SCREEN

MEASUREMENT SCREEN

Patient No. (Patient ID when patient ID is input) → 0000100001000
 Number of reading/setting (R, REF) → 03/03
 Refractive power measurement result (R) → S - 1.25, C - 0.50
 Number of reading/setting (R, KRT) → 03/03
 *Eye Height mark → R1 7.80, R2 7.75
 Corneal curvature radius measurement result (R) → A 180
 Peripheral KRT value (R) → PR1 7.80, PR2 7.75
 Device ID number → 01 mm
 D/mm unit display → - 1.25 C - 0.50 A 180 S - 1.25 C - 0.50 A 180
 Alignment mark → (Top center square)
 Outer alignment mark → (Top corners squares)
 Operator ID → 0000100001000
 Number of reading/setting (L, REF) → 03/03
 Refractive power measurement result (L) → S - 1.25, C - 0.50
 Number of reading/setting (L, KRT) → 03/03
 Corneal curvature radius measurement result (L) → A 180
 Peripheral KRT value (L) → PR1 7.80, PR2 7.75
 VD (Vertex distance) → 12.00
 Typical value of R measurement → (Left side data)
 Typical value of L measurement → (Right side data)

*Eye Height mark: Shows the position of the eye height mark on the chinrest.

SETTINGS SCREEN

Initial	Buzzer	ON	OFF
Print	Start mode	AUTO	ON
Comm	Auto Print	ON	
LAN	Printer	ON	
Examiner	Serial No. reset	OFF	
Special	Show patient ID	ON	
	Required patient ID	OFF	
	Device ID	1	

CORNEA DIAMETER MEASUREMENT SCREEN

R: [Diagram] L: 9.80
 [Navigation buttons: R, L, Up/Down arrows, Home, Back, Forward]

PRINTER OUTPUT

KRT typical value style and KRT print format are HV

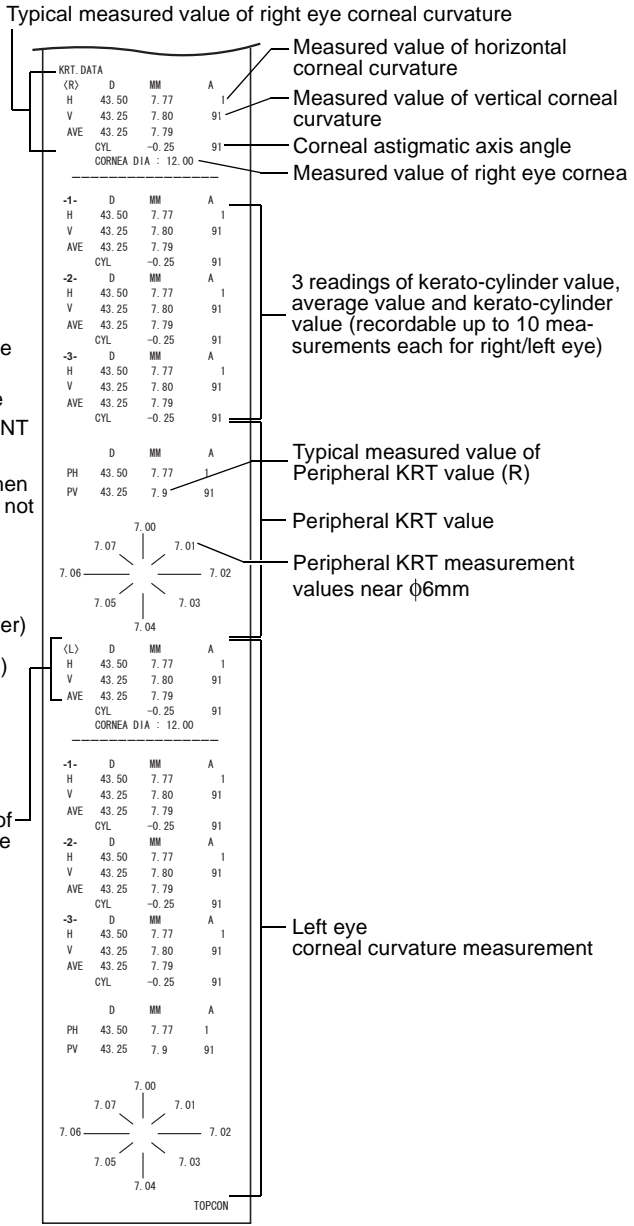
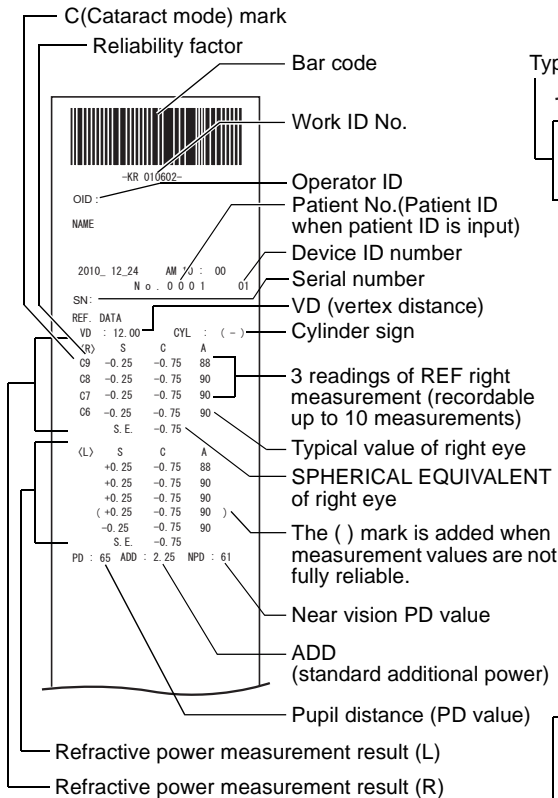

The reliability factor is defined with integers 1 to 9 in increasing order of reliability. Additionally, if the reliability is high enough, the reliability factor is not shown on the printout.



The Near PD value is calculated based on the ADD.

KRT typical value style and KRT print format are R1R2

Barcode

Work ID No.: -KR 010602-

Operator ID: OID :

NAME

Patient No. (Patient ID when patient ID is input): 2010_12_24 AM 10 : 00

Device ID number: No . 0 0 0 1 01

Serial number: SN :

VD (vertex distance): REF. DATA VD : 12.00

Cylinder sign: CYL : (-)

3 readings of REF right measurement (recordable up to 10 measurements): (R) S C A
C9 -0.25 -0.75 88
C8 -0.25 -0.75 90
C7 -0.25 -0.75 90

Typical value of right eye: -0.25 -0.75 90

Spherical equivalent of right eye: S. E. -0.75

The () mark is added when measurement values are not fully reliable.: (L) S C A
+0.25 -0.75 88
+0.25 -0.75 90
+0.25 -0.75 90
(+0.25 -0.75 90)

Near vision PD value: PD : 65 ADD : 2.25 NPD : 61

ADD (ordinary additional power): ADD : 2.25

Pupil distance (PD value) (mm): PD : 65

Measured value of horizontal corneal curvature: (R) D MM A
R1 43.50 7.77 1

Measured value of vertical corneal curvature: R2 43.25 7.80 91

D: Average value of corneal refractive power: AVE 43.25 7.79

MM: Average value of cornea curvature radius: CYL -0.25 91

Corneal astigmatic axial angle: CORNEA DIA : 12.00

Measured value of right eye cornea diameter (mm): MM1 MM2 A1
1 43.25 43.50 91
AVE 43.25 7.79
CYL: -0.25 91
2 43.25 43.50 93
AVE 43.25 7.79
CYL: -0.25 91
3 43.25 43.50 93
AVE 43.25 7.79
CYL: -0.25 91

KRT data (Right eye)

MM1: Corneal refractive power at flat meridian: (L) D MM A
R1 43.50 7.77 143

MM2: Corneal refractive power at steep meridian: R2 43.25 7.80 53

A1: Angle of steep meridian: AVE 43.25 7.79 53
CYL -0.25 91
CORNEA DIA : 12.00
MM1 MM2 A1
1 43.25 43.50 103
AVE 43.25 7.79
CYL: -0.25 91
2 43.25 43.50 98
AVE 43.25 7.79
CYL: -0.25 91
3 * 43.25 43.50 93
AVE 43.75 44.50 93
CYL: -0.25 91

KRT data (Left eye)

TOPCON



The reliability factor is defined with integers 1 to 9 in increasing order of reliability. Additionally, if the reliability is high enough, the reliability factor is not shown on the printout.



The Near PD value is calculated based on the ADD.

PRINTOUT FORMAT SETTING

Printout format can be changed by pushing "Print" in the Settings screen. For Print settings, see "SETTING FUNCTIONS ON SETUP SCREEN" on page 44.

PRESET

ALL: Initial setting (all measurement values are printed.)







AVE: Only typical value are printed.

CLASSIC: Equivalent with RM/KR-8900 Classic 2

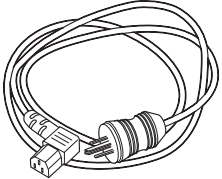
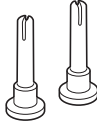
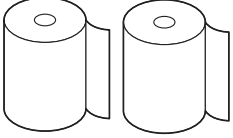
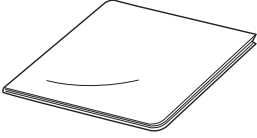
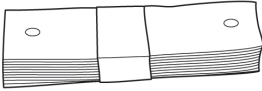
	ITEM	INITIAL	PRESET		
			ALL	AVE	CLASSIC
Common	Barcode	OFF	OFF	OFF	OFF
	Examiner ID	OFF	OFF	OFF	OFF
	Name	ON	ON	ON	ON
	Date	ON	ON	ON	ON
	Date style	YMD	YMD	YMD	YMD
	Patient ID	ON	ON	ON	ON
	Device ID number	OFF	OFF	OFF	OFF
	Serial number	ON	ON	ON	ON
	Include error data	OFF	OFF	OFF	OFF
	TOPCON logo	ON	ON	ON	ON
	Message	OFF	OFF	OFF	OFF
	Message data	NULL	NULL	NULL	NULL
Between the lines	0	0	0	0	
REF/KRT	Print order	DATA	DATA	DATA	DATA
	VD	ON	ON	ON	ON
	Cylinder sign	ON	ON	ON	ON
	REF format	ALL	ALL	AVE	ALL
	Credibility	OFF	OFF	OFF	OFF
	S.E.	ON	ON	ON	ON
	PD	ON	ON	ON	ON
	ADD	OFF	OFF	OFF	OFF
	KRT print order	D/mm	D/mm	D/mm	D/mm
	KRT format	ALL	ALL	AVE	AVE
	KRT type	R1R2	R1R2	R1R2	HV
	KRT format detail	R1R2	R1R2	R1R2	HV
	KRT average	ON	ON	ON	ON
	KRT cylinder	ON	ON	ON	ON
Cornea diameter	ON	ON	ON	ON	
REF	VD	ON	ON	ON	ON
	Cylinder sign	ALL	ALL	AVE	ALL
	REF format	OFF	OFF	OFF	OFF
	Credibility	ON	ON	ON	ON
	S.E.	ON	ON	ON	ON
	PD	OFF	OFF	OFF	OFF
	ADD	OFF	OFF	OFF	OFF
KRT	KRT print order	D/mm	D/mm	D/mm	D/mm
	KRT format	ALL	ALL	AVE	ALL
	KRT type	R1R2	R1R2	R1R2	HV
	KRT format detail	R1R2	R1R2	R1R2	HV
	KRT average	ON	ON	ON	ON
	KRT cylinder	ON	ON	ON	ON
Cornea diameter	ON	ON	ON	ON	

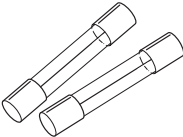

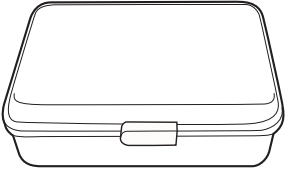
STANDARD ACCESSORIES

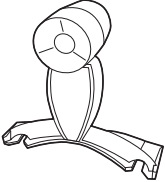
The following are standard accessories. Make sure that all these items are included (quantity).

<p>Power cable (1)</p> 	<p>Chinrest tissue pin (2)</p> 
<p>Printer paper (2)</p> 	<p>Monitor cleaner (1)</p> 
<p>Chinrest tissue (1)</p> 	<p>Dust cover (1)</p> 
<p>Fuse (2)</p> 	<p>Instruction Manual (1)</p> 
<p>Accessory case (1)</p> 	<p>User manual and unpacking manual (1 each)</p> 
<p>Rubber cap (1)</p> 	<p>Model eye (1)</p> 

PREPARATIONS



INSTALLATION

 CAUTION	When moving the instrument, two people should lift from the bottom of the device. One person lifting the device may cause harm to his back or injury by falling parts. Also, holding areas other than the bottom and holding the External I/O terminal cover may cause injury, as well as damage to the instrument.
 CAUTION	To prevent damage and injuries, do not install the instrument on an uneven, unsteady or sloped surface.
 CAUTION	When setting an instrument on an instrument table, pay attention not to injure the patient's fingers between the instrument and the table.
NOTE:	The instrument should also be placed away from strong light like direct sunlight. Auto alignment may not function properly.

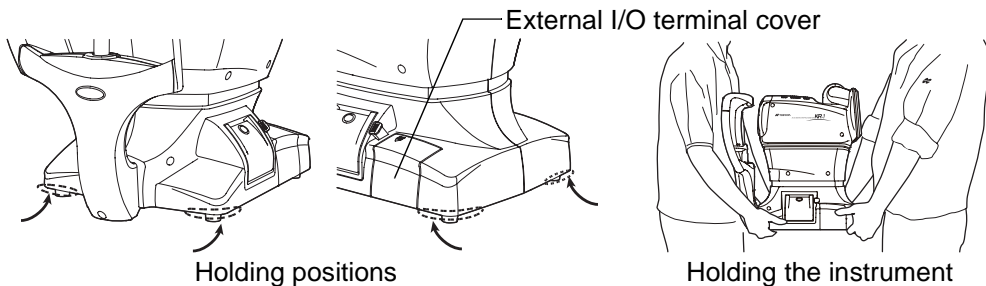
- 1 Firmly hold the instrument at the position shown below and place it on the automatic instrument table.
For the adjustable instrument table, see "OPTIONAL ACCESSORIES" on page 64.



CONNECTING POWER CABLE

 WARNING	Be sure to connect the power plug to an AC 3-pin receptacle equipped with grounding. Connection with receptacle without grounding may cause fire and electric shock in case of short-circuiting.
 CAUTION	To avoid electric shocks, do not handle the power plug with wet fingers.

- 1 Make sure the POWER switch of the instrument is OFF.

- 2** Tilt the body slowly so that the POWER switch is on top and the power inlet at the bottom can be seen.
- 3** Connect the power cable to the Power inlet.
- 4** Insert the power cable plug into the 3-pin AC grounding receptacle.

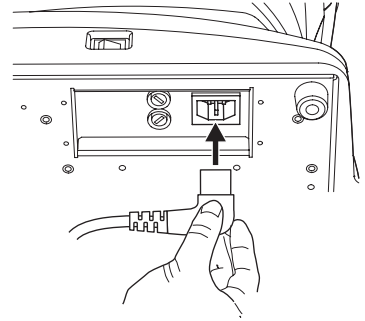

CONNECTING EXTERNAL I/O TERMINALS



CAUTION

To avoid electric shock, do not touch the external connection terminal and the patient at the same time.



Use the external device complying with IEC60950/IEC60950-1.

DATA OUTPUT

This product can be connected to a personal computer (PC) and other external devices via the RS232C or LAN.

- 1** Remove the External I/O terminal cover by pulling up as follows.

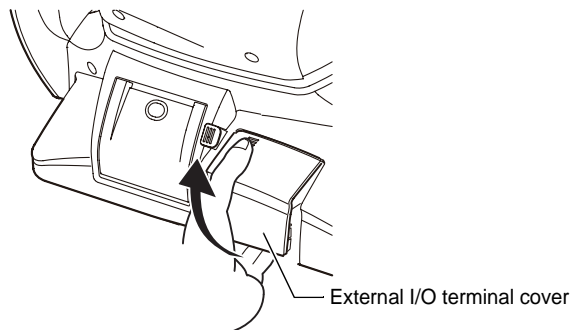

- 2** Connect the connection cable to the output terminal of the instrument.

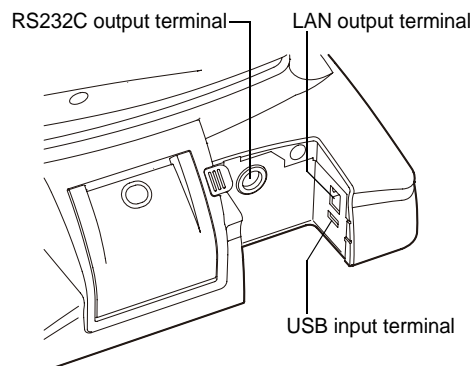

- 3** Connect the other end of the connection cable to the PC, etc.
- 4** Replace the External I/O terminal cover.

DATA INPUT

This product can be connected to a bar-code reader and other external devices via USB.

- 1** Connect the connection cable to the input terminal of the instrument.
- 2** Connect the other end of the connection cable to the external device.



For questions about connections, contact your TOPCON dealer.

PRINTER PAPER SETTING

	CAUTION	To avoid failure or potential injury, do not open the printer cover while the printer is in operation.
	CAUTION	To avoid potential injury in case of malfunction, including a paper jam, be sure to shut off the power before attempting to repair it.
	CAUTION	To avoid potential injury, do not touch the printer body including metal parts or the paper cutter, while the printer is in operation or when replacing the printer paper.
NOTE:		• If you insert the printer paper backwards, printing will not start.

- 1** Press the printer cover open switch to open the printer cover.

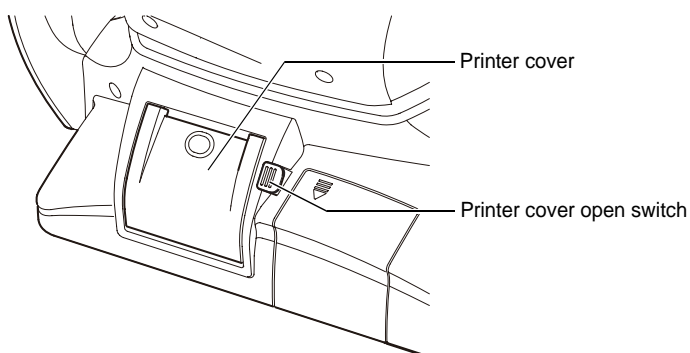

2 Open the printer cover to the limit.



3 Insert the printer paper in the direction shown below and pull out the paper end to your side by 7 to 8cm.

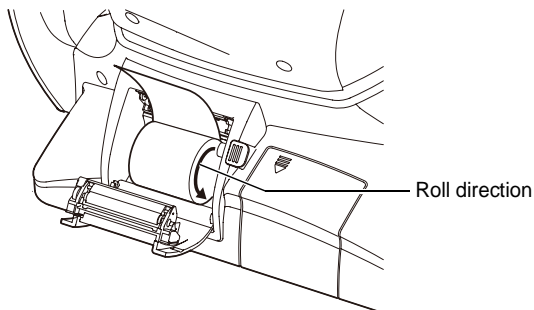

4 Bring the paper into the center, then close the printer cover.

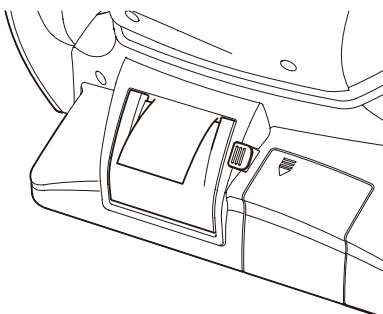

In case the printer cover is not firmly closed, printing will not start, and "CLOSE PRT COVER" will be displayed on the monitor screen.



A 58mm wide paper roll (example: TP-50KJ-R [Nippon Paper Co.]) is recommended.

Other paper rolls may cause abnormal printing noise or unclear print.

RECOVERY FROM POWER SAVE STATUS

This instrument adopts the power save system for saving electric power. When the machine is not operated for a set time, the control panel becomes a screensaver.

1 Tap the control panel.

In a few seconds, the measurement screen is displayed and measurement is enabled.



The time to start the power save status can be changed in the initial setting "Auto power save" (see page 48).

ADJUSTING THE CONTROL PANEL POSITION

The control panel may be positioned by swinging and tilting the monitor to your desired position. Touching the control panel controls operations including chinrest movements, alignment and measurement.

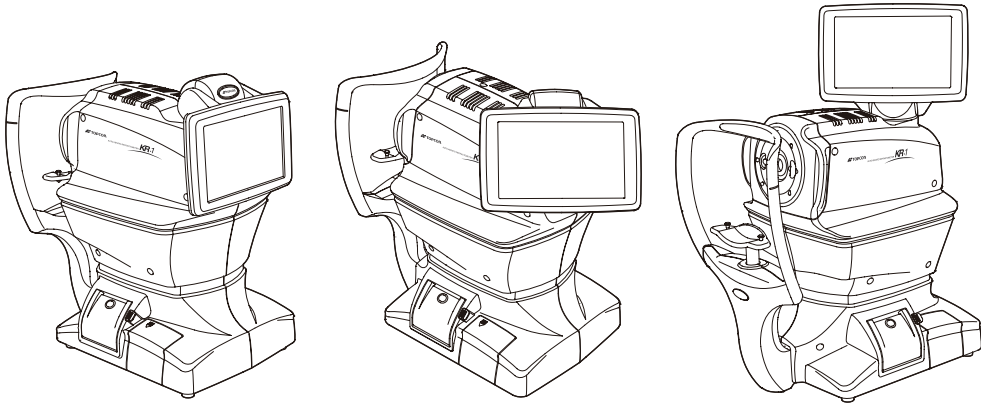

BASIC OPERATIONS

PREPARATION BEFORE MEASUREMENT

TURNING ON THE INSTRUMENT

- 1** Make sure the power cable is connected properly.
For the details of connection, refer to “CONNECTING POWER CABLE” on page 19.
- 2** Press on the **POWER** SWITCH.
- 3** Make sure that the title screen is displayed and then the MEASUREMENT screen is displayed in a few seconds.

SELECTING THE MEASUREMENT MODE



This product has three measurement modes: R/K (REF/KRT continuous measurement), KRT (KRT single measurement) and REF (REF single measurement).

- 1** Check that the MEASUREMENT screen is on.
- 2** Tap the **MEASUREMENT MODE** button on the control panel and select the measurement mode. Indication of the **MEASUREMENT MODE** button is changed.

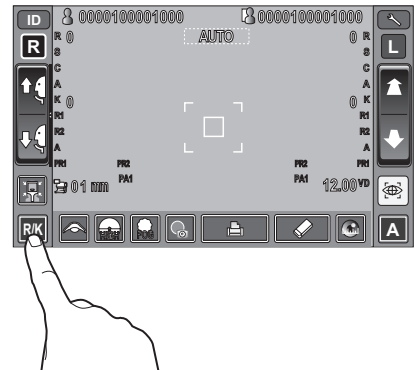
- REF: Only REF measurement
- KRT: Only KRT measurement
- R/K: REF/KRT continuous measurement



PATIENT POSITIONING

 CAUTION	To avoid electric shock, do not touch the external connection terminal and the patient at the same time.
 CAUTION	To avoid injury when moving the chinrest up/down button, be careful not to catch the patient's fingers.
 CAUTION	To avoid injury when operating the machine, be careful about the cover not to catch fingers of the patient. Tell this to the patient, too.
NOTE:	Adjust the height of the adjustable instrument table so that the patient can sit on the chair comfortably. Otherwise, correct measurement values may not be obtained.
NOTE:	When operating the instrument, be careful that the instrument does not touch the patient's lip or nose. If touched, clean the instrument following "CLEANING THE INSTRUMENT" on page 65.

- 1 Check the measurement screen.
- 2 Make sure that the eye height mark is at the center position as explained below.
 If the eye height mark is above the center position, press the lower side of the control panel display, or if it is below the center position, press the upper side of the control panel display, so as to move the eye height mark to the center position.

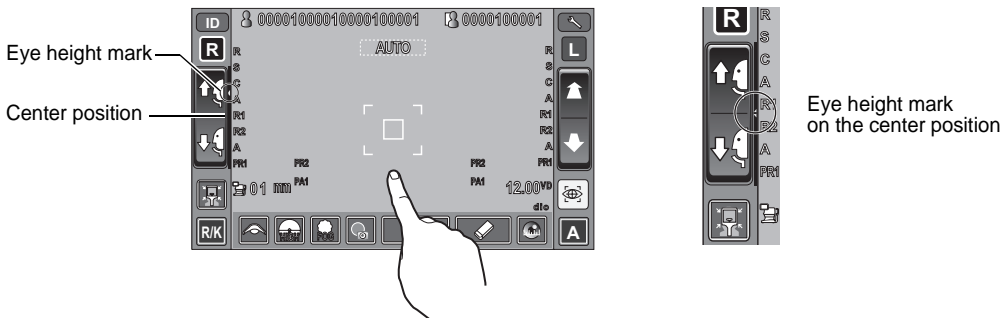

- 3 Have the patient sit in front of the instrument.
- 4 Adjust the adjustable instrument table or the chair height for the patient to put his/her chin on the chinrest comfortably.

- 5** Place the patient's chin on the chinrest and check that his/her forehead is touching to the forehead rest.

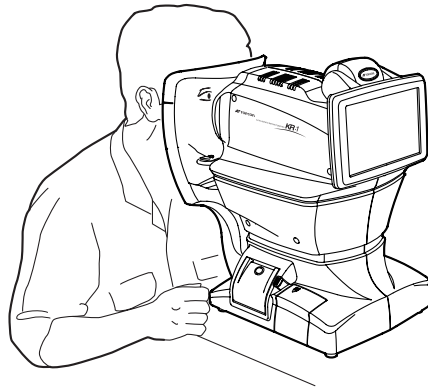

- 6** Press the **UP/DOWN** button to adjust the chinrest height until the eye height mark of the chinrest reaches the same height as the patient's eye. At this moment, confirm that the height mark of the measuring window is at the height of the patient's visual line.

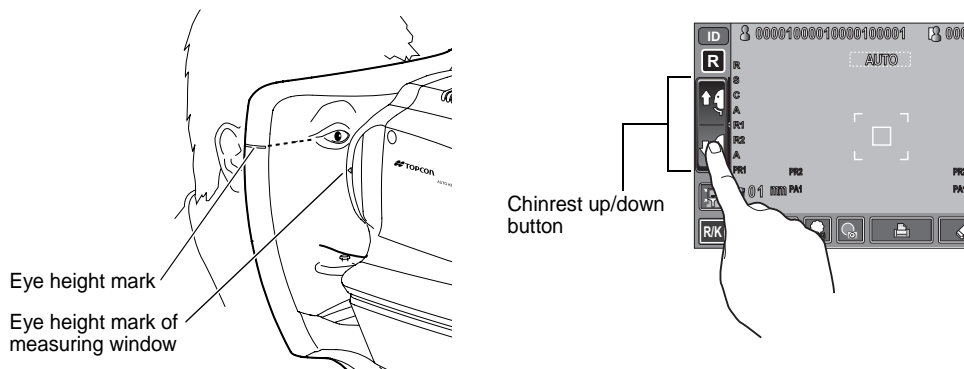

AUTO MODE MEASUREMENT

NOTE:	Auto measurement mode may not be possible, in case the eyelid and the eyelashes cover the pupil. If this occurs, the operator should tell the patient to open their eyes as wide as possible, or lift the eyelid to allow for measurement.
NOTE:	Auto measurement mode may not be possible due to frequent blinks or existing abnormalities in the corneal surface caused corneal disease etc. In this case, select manual mode.
NOTE:	When operating the instrument, be careful that the instrument does not touch the patient's face or nose. If touched, clean the instrument as specified in "CLEANING THE INSTRUMENT" on page 65.
NOTE:	If the patient is wearing make up on the eyelid or around the eyelid using glitter, the auto alignment may not function properly. In this case, select manual mode.

SETTING THE AUTO MODE

- 1 Make sure the **AUTO/MANUAL** button is on A on the measurement screen. "A" is Auto mode.
- 2 If "M" (Manual mode) is displayed, tap it and change to the Auto mode.

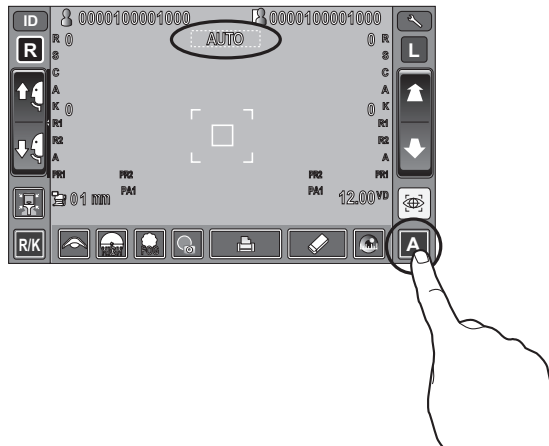

ALIGNMENT AND MEASUREMENT

Alignment can be operated from the control panel.

- 1 When the pupil is displayed, tap the display around the pupil. The measuring head moves to display the pupil image and alignment dot on the center of the screen. Then tell the patient to look at red-roof house.

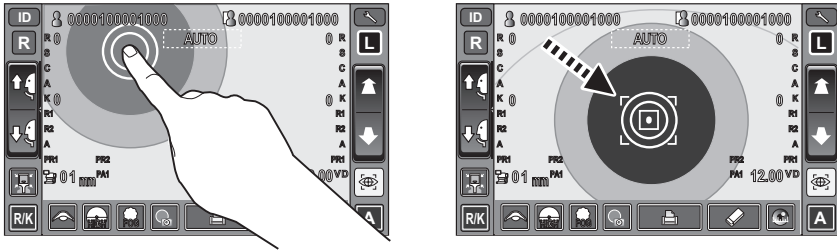

If the pupil is not displayed on the control panel, move the measuring head by press the control panel, checking the eye height mark on the measurement window as a guide (see page 26).



When the measuring head has reached the limit of movement (vertical/lateral directions), a yellow-colored limit mark appears, showing it is the movement limit in that direction. Tap the display, move the measuring head to a position until pupil image comes to the center.

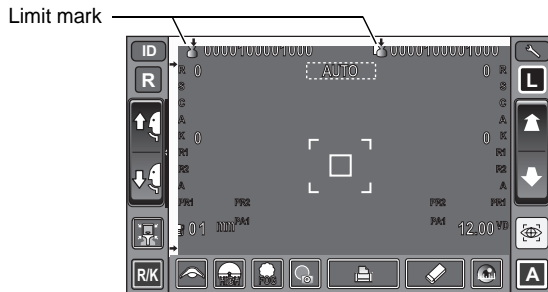

When the measuring head is at the limit of movement in the forward direction, "TOO CLOSE" is displayed and the buzzer sounds, and when it is at the limit of movement in the backward direction, "TOO FAR" is displayed. Using the Measuring Head Forward button and Measuring Head Backward button, move the measuring head to a position until pupil image comes to the center.

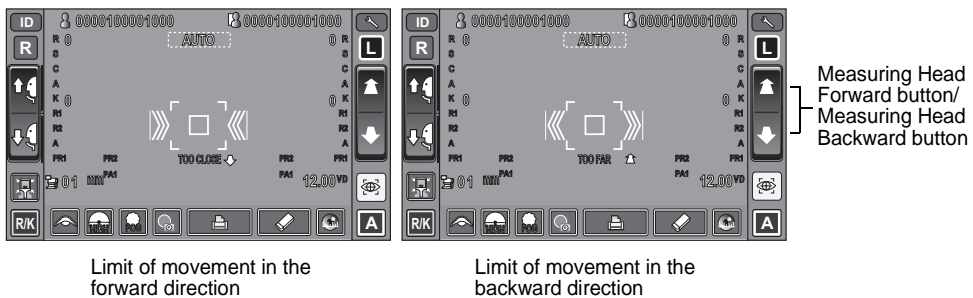

- 2 Alignment starts automatically, and measurement is performed. The measurement result is displayed.

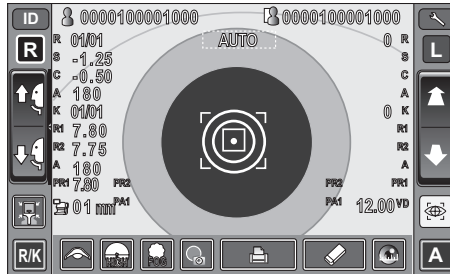

- 3 When Right/Left eye continuous measurement is selected, the instrument measuring head moves automatically from the right to the left eye.

NOTE:	If auto mode measurement does not work, select manual mode. Auto mode measurement may not work depending on the cornea condition.
--------------	---

NOTE:	If the machine is moved before measurement values are displayed, it might cause an incorrect measurement.
--------------	---



Auto print (available only under Auto mode)

When auto print setting is "ON" in the initial setting, the buzzer sounds twice after measuring the right and left eyes, and measurement results are printed out automatically.

DISPLAYING MEASUREMENT VALUES

Data of the latest measurement are displayed on the control panel screen.

Figures only: Measurement was done correctly.

ERROR: Measurement was not done correctly.



For explanation of the messages on the control panel screen, refer to "MESSAGE LIST" on page 54.

When auto print setting is "OFF" in the initial setting, print out measurement results by tapping the Print button, as necessary.

MANUAL MODE MEASUREMENT

SETTING THE MANUAL MODE

- 1 Check the MEASUREMENT screen is on. If the **AUTO/MANUAL** button is "M," the mode is Manual mode.
- 2 If "A" (Auto mode) is displayed, tap it and change to "M".

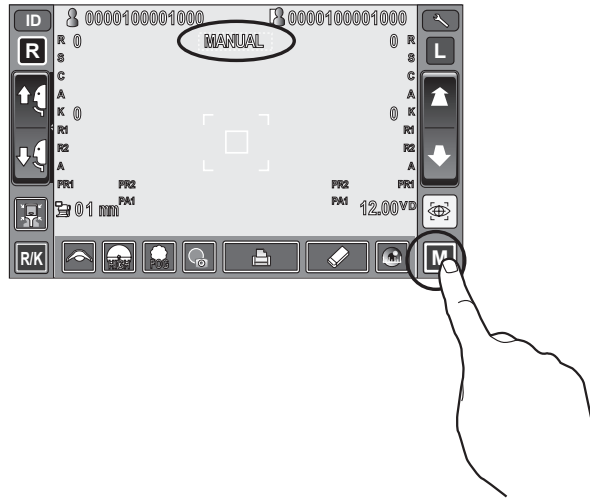

ALIGNMENT AND MEASUREMENT

Alignment is operated on the control panel.

- 1 Select the right/left eye by tapping the **(R)** button/**(L)** button.

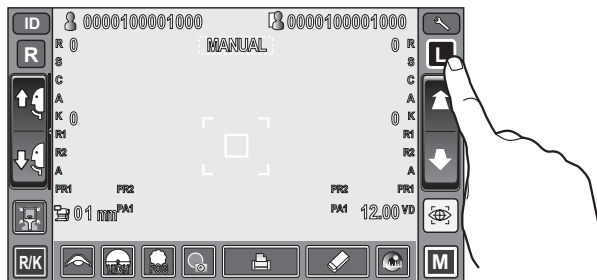

- 2 When the pupil is displayed, tap the display around the pupil. The measuring head moves to display the pupil image and alignment dot on the center of the screen. Then tell the patient to look at red-roof house.

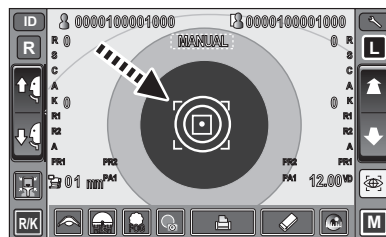
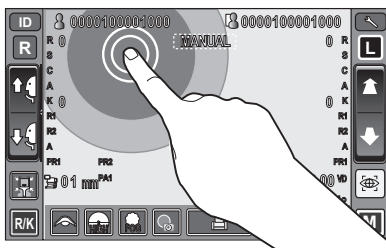



If the pupil is not displayed on the control panel, move the measuring head by press the control panel, checking the eye height mark on the measurement window as a guide (see page 26).



When the measuring head has reached the limit of movement (vertical/lateral directions), a yellow-colored limit mark appears, showing it is the movement limit in that direction. Tap the display, move the measuring head to a position until pupil image comes to the center.

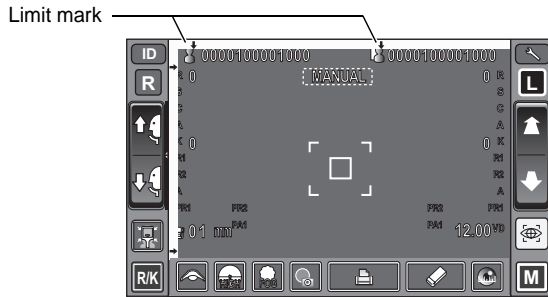

When the measuring head is at the limit of movement in the forward direction, "TOO CLOSE" is displayed and the buzzer sounds, and when it is at the limit of movement in the backward direction, "TOO FAR" is displayed. Using the Measuring Head Forward button and Measuring Head Backward button, move the measuring head to a position until pupil image comes to the center.

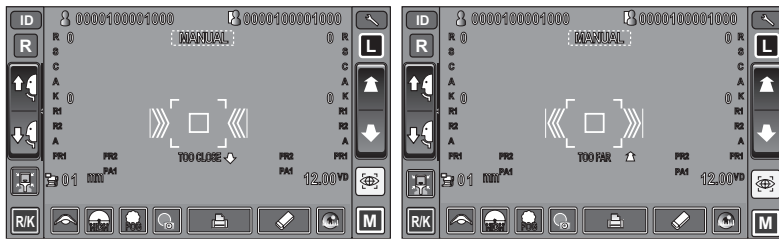

Measuring Head Forward button/
Measuring Head Backward button

Limit of movement in the forward direction

Limit of movement in the backward direction

- 3 Tap the **MEASURING HEAD FORWARD** button/**MEASURING HEAD BACKWARD** button and focus on the patient's eye. Alignment dot is reflected off-focus on the cornea.

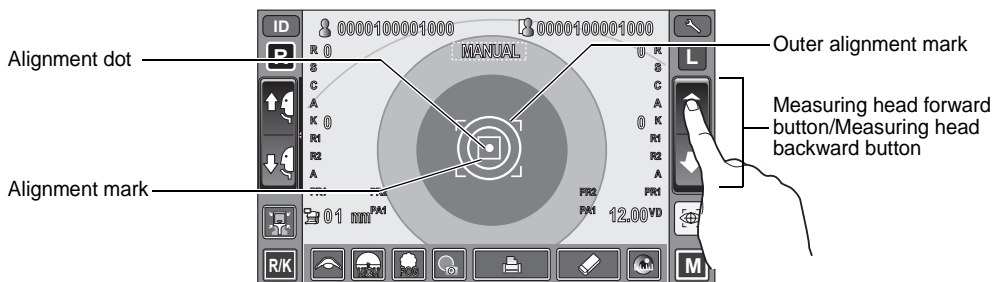

- 4** When the main body is brought closer to the patient's eye, alignment arrows appear on the control panel screen.

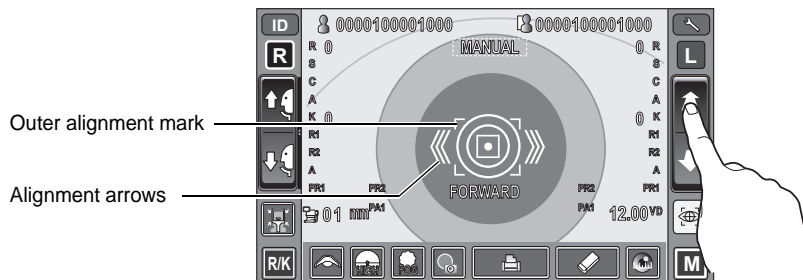

Do not allow the eyelash and eyelid to cover the outer alignment mark to ensure stable measurement.



If the machine is too near to the patient in comparison with the optimal alignment position, the alignment arrows are displayed outward with the message "BACKWARD," or if it is too far from the patient, the alignment arrows are displayed inward with the message "FORWARD." The number of arrow are reduced accordingly as the optimal alignment reference position comes closer.

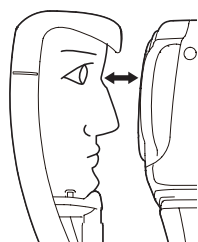

Too close

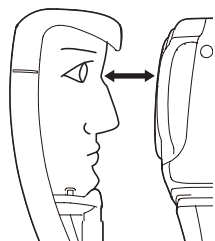
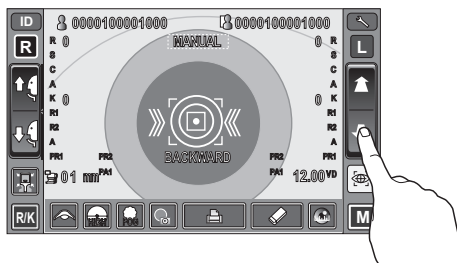

Too far

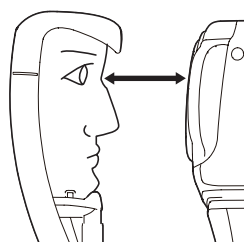
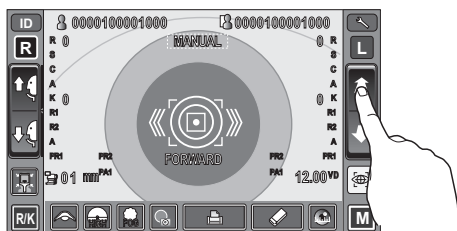

Off the alignment range

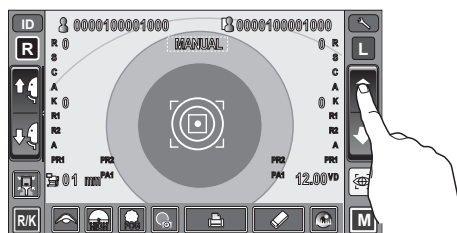

- 5 When the alignment dot becomes smaller in size and "Alignment OK" is displayed, tap the **START** button.



Even if fine alignment has not been achieved, measurement can be performed by tapping the **START** button. To ensure correct measurement, try to get fine alignment.



Measurements can be performed off center if necessary by tapping the **START** button after placing the measuring head in the desired off center position.

- 6 Measurement is performed and measurement values are displayed on the control panel.

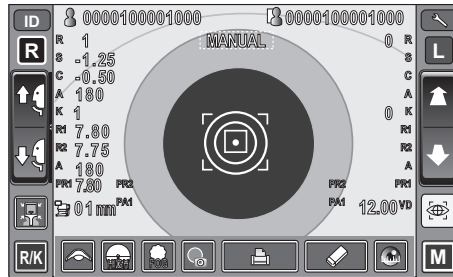

After finishing the measurement, auto alignment is performed if the patient's eye position is moved right/left and up/down.

NOTE: If the machine is moved before measurement values are displayed, it may cause incorrect measurement result.

DISPLAYING MEASUREMENT VALUES

Data of the latest measurement are displayed on the control panel screen.

Figures only: Measurement was done correctly.

ERROR: Measurement was not done correctly.



For explanation of messages on the control panel screen, refer to "MESSAGE LIST" on page 54.

PRINT-OUT OF MEASUREMENT VALUES

NOTE:	<ul style="list-style-type: none">• To avoid a paper jam in the printer, do not feed the paper if it is partly cut or wrinkled.• To avoid discoloring of the printer paper (particularly the recording area) during storage, use a polypropylene bag and not one containing plasticizer (PVC, etc.).• To avoid discoloring of the printer paper (particularly the recording area) after pasting, use water-soluble glue and not one containing solvent.• Since the printer paper is thermosensitive, it is not suitable for keeping records for a long period. If necessary, prepare copies separately.
--------------	--

This instrument can print out measurement values by a printer.

1 Check the Measurement screen is on.

2 Tap the **PRINT OUT** button on the control panel.

Measurement values on the monitor are printed out.

After being printed out, the measurement values on the screen are deleted automatically.



When the cylindrical refractive power is "0," the direction of astigmatic axis and measurement values are not displayed/printed.



When a red line is printed at the end of the printer paper, replace it with a new one. For details about the replacement of printer paper, see "PRINTER PAPER SETTING" on page 21. 58mm wide printer paper (example: TP-50KJ-R, Nippon Paper) is recommended.



"CLOSE PRT COVER" is indicating that the printer cover is left opened, ensure that the printer cover is completely closed.



When auto print is setting is "ON" in the initial setting, measurement is performed under Auto mode, and measurement results are printed out automatically. (See page 48.)



After printing out measurement values, the measuring head moves to the "finish mode" position of the initial setting.

CLEARING MEASUREMENT VALUES

- 1 Tap the **ALL CLEAR** button on the control panel.
All measurement values of both eyes are cleared.

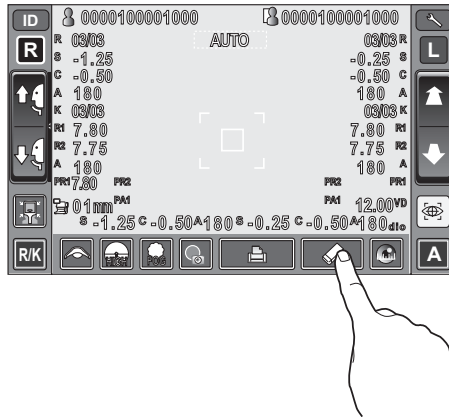

DISPLAYING ALL MEASUREMENT DATA

Normally the latest measurement is displayed, but it is possible to display and confirm all measurement data.

- 1 Tap the **TARGET IMAGE** button of the control panel.

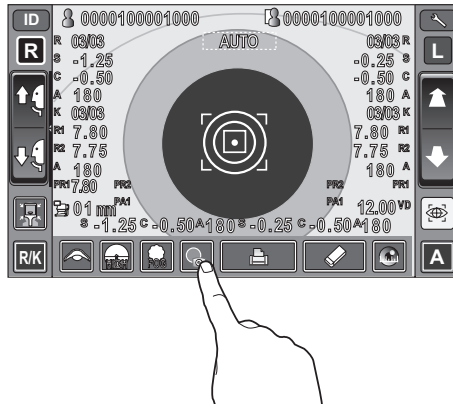

- 2 Tap the **ALL DATA DISPLAY** button.

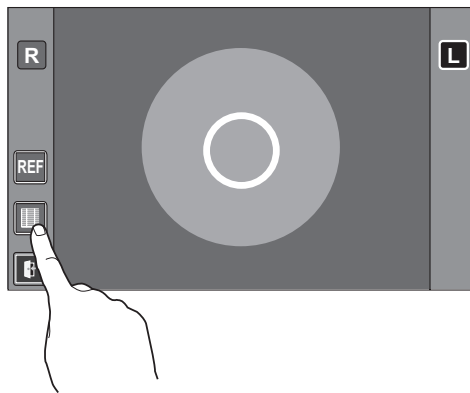

- 3 The Data Display screen is displayed.

RIGHT				LEFT			
	S	C	A		S	C	A
C1	-1.25	-0.50	180	1	-0.25	-0.50	180
2	-1.25	-0.50	180	2	-0.25	-0.50	180
(3)	-1.25	-0.50	180	3	-0.25	-0.50	180
4				4			
5				5			
6				6			
7				7			
8				8			
9				9			
10				10			
AVE	-1.25	-0.50	180	AVE	-0.25	-0.50	180

When measurement is performed with the Cataract button ON, "C" comes at the head of figures.

When Cataract mode starts automatically during the measurement, figures will be put in ().

RIGHT				LEFT			
	S	C	A		S	C	A
C1	-1.25	-0.50	180	1	-0.25	-0.50	180
2	-1.25	-0.50	180	2	-0.25	-0.50	180
(3)	-1.25	-0.50	180	3	-0.25	-0.50	180
4				4			



When no data is memorized, the data table shows blank.

4 To change "REF data" and "KRT data," tap the REF/KRT button.

RIGHT				LEFT			
	R1	R2	A		R1	R2	A
1	7.80	7.75	180	1	7.80	7.75	180
2*	7.80	7.75	180	2	7.80	7.75	180
3*	7.80	7.75	180	3	7.80	7.75	180
4				4			
5				5			
6				6			
7				7			
8				8			
9				9			
10				10			
AVE	7.80	7.75	180	AVE	7.80	7.75	180

When the reliability of KRT data is low, "*" is attached after the figures.

RIGHT				LEFT			
	R1	R2	A		R1	R2	A
1	7.80	7.75	180	1	7.80	7.75	180
2*	7.80	7.75	180	2	7.80	7.75	180
3*	7.80	7.75	180	3	7.80	7.75	180
4				4			

5 To exit the data display and return to the Measurement screen, tap the **EXIT** button.

RIGHT				LEFT			
	R1	R2	A		R1	R2	A
1	7.80	7.75	180	1	7.80	7.75	180
2*	7.80	7.75	180	2	7.80	7.75	180
3*	7.80	7.75	180	3	7.80	7.75	180
4				4			
5				5			
6				6			
7				7			
8				8			
9				9			
10				10			
AVE	7.80	7.75	180	AVE	7.80	7.75	180

OPERATION OF AFTER USE

1 Turn the POWER switch to off.



When external devices are connected to external I/O terminals, turn off the power of these devices too.

2 Unplug the power cable from a 3-pin AC inlet with grounding.



When the instrument is not used for a long period, unplug the power supply cable, and detach the cable connected to the external I/O terminal.

OPTIONAL OPERATIONS

DISPLAYING THE PATIENT ID (PATIENT No.) OR EXAMINER ID

A patient ID or examiner ID of up to 13 characters can be input and displayed on the control panel and printout.

However, if no patient ID is input, the patient No. is allocated automatically by the device.

1 Tap (ID) button.

2 Tap keyboard on the screen and enter characters. Tap (OK) button and fix the input value.



Patient ID is reset when measurement values are printed or if the (ALL CLEAR) button is tapped.

Patient No. reset condition can be selected such that the patient No. is reset upon power on or not, in the initial setting of setup screen.

"Refer to "Patient No.reset" on page 48.

MEASURING ONE EYE ONLY

In Auto mode, it is possible to measure one eye only.

The current measurement position is distinguished by the color of the **R**/**L** button; orange indicates active measurement position.

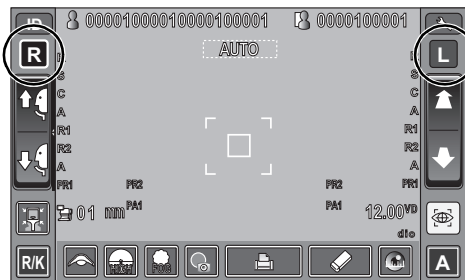

MEASURING THE RIGHT EYE ONLY

1 Tap the **R** button to move the measuring head to the right.

2 When the measuring head stops moving tap the **R** button once again: the lock icon is displayed **R_l**.

- When the lock icon is displayed, the measuring head does not move to the other eye even when the measurement of one eye is finished.

3 To release the lock, tap the **R_l** icon: The lock icon disappears.

MEASURING THE LEFT EYE ONLY

Operation is the same as measuring the right eye.



In order to measure the other eye when the lock icon is displayed, tap the other side **R** button or **L** button.

MEASUREMENT OF CORNEA DIAMETER

MEASUREMENT ON THE ACTUAL IMAGE

1 Tap the **(R)** button/**(L)** button to select the right/left eye.

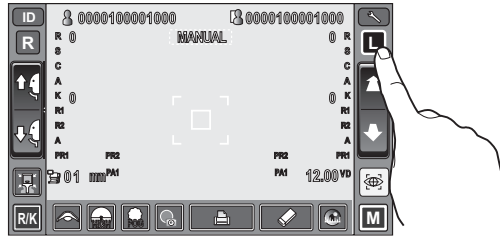

2 Tap the **CORNEA DIAMETER** button.

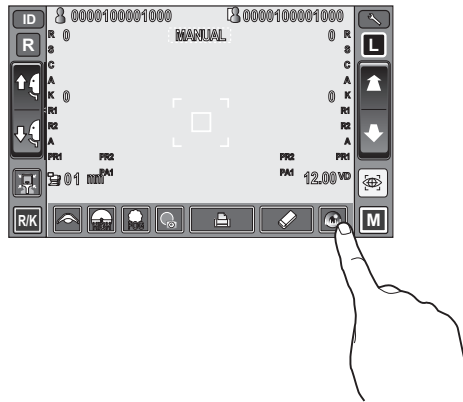

3 The Cornea Diameter Measurement screen is displayed, and The positioning bar is displayed.

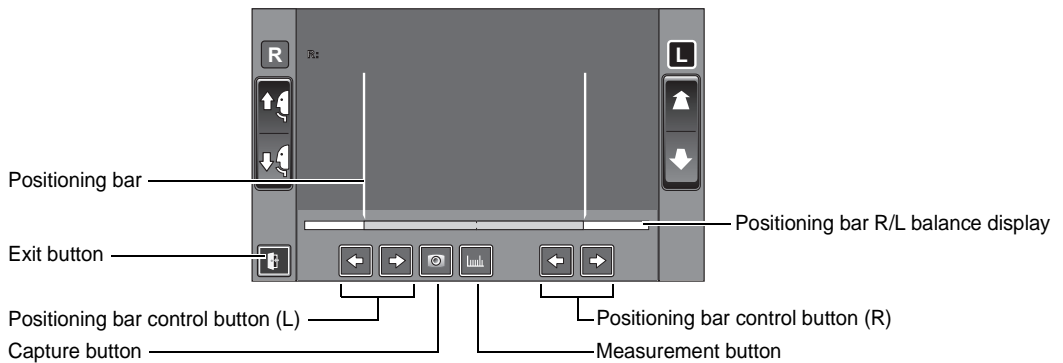

- 4** When the pupil is displayed, tap around the pupil. The measuring head moves to display the pupil image and alignment dot at the center of the screen.

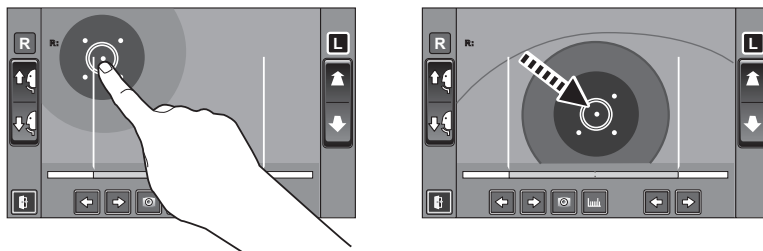

- 5** Using the **POSITIONING BAR CONTROL** button (L), move the left positioning bar to the left end of the iris from the operator side.

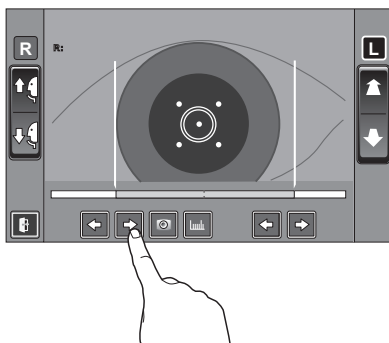

- 6** Using the **POSITIONING BAR CONTROL** button (R), move the right positioning bar to the right end of the iris from the operator's side.

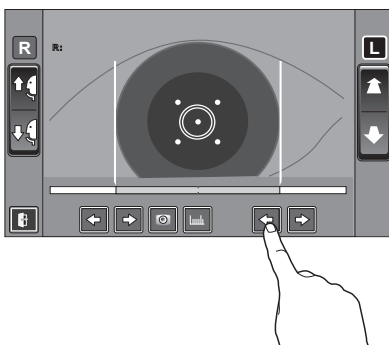

- 7** Tap the **MEASUREMENT** button.

- 8** The cornea diameter is displayed.

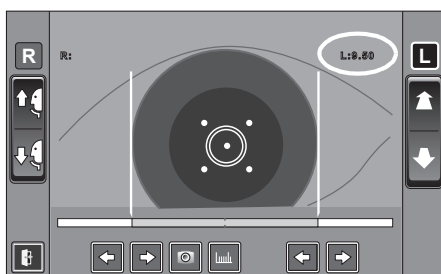

- 9 Tap the **(R)** **(L)** button and move to the other eye.
In like manner, measure the other eye.
- 10 Tap the **(EXIT)** button and measure the other eye.

MEASUREMENT ON THE STILL IMAGE

When KRT measurement values are available, the still image of the measurement is displayed.

- 1 Follow steps 1 to 5 of "MEASUREMENT ON THE ACTUAL IMAGE" and display the cornea image at the screen center.
- 2 Tap the **(CAPTURE)** button. The eye image is displayed full-screen, and the cornea image is saved.

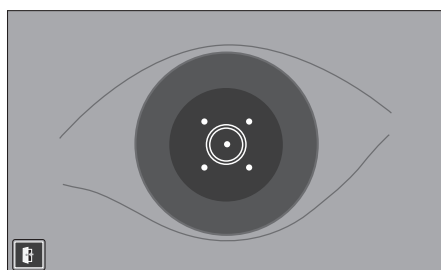
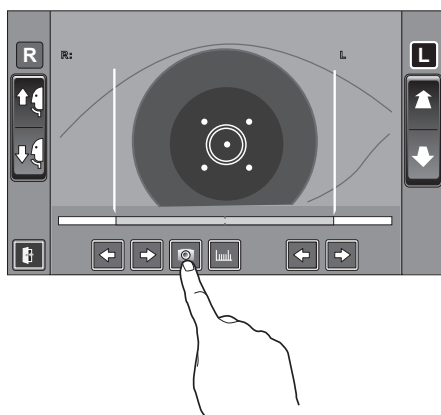

- 3 Tap **(EXIT)** button to exit the full-screen display.
The **(MEMORY)** button appears indicating that the image is saved.

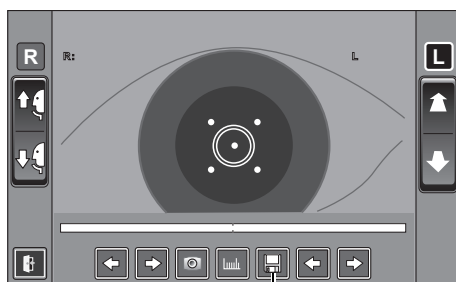

Memory button

- 4 Tap the **(MEMORY)** button to display the saved image.

- 5** Tap either of the (R)/(L) **POSITIONING BAR CONTROL** buttons and move the positioning bar.

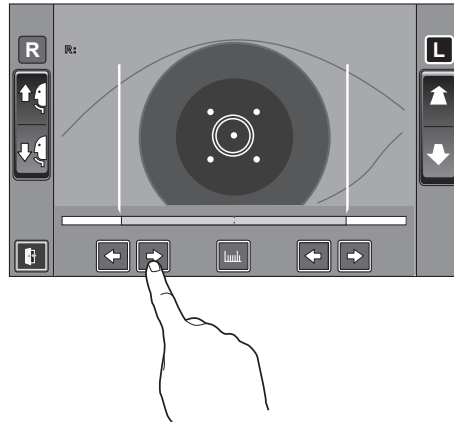

- 6** Follow steps **6** to **8** of "MEASUREMENT ON THE ACTUAL IMAGE."
7 The cornea diameter is displayed.

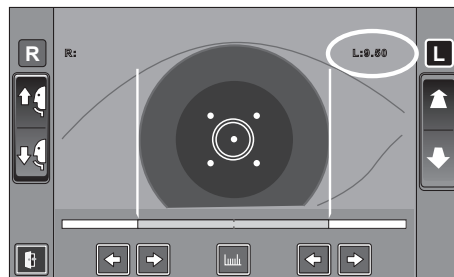

OUTPUT USING RS232C

This instrument can output data to a PC, etc via the RS232C interface.

- 1** Connect the interface cable to RS232C OUT.
Refer to "CONNECTING EXTERNAL I/O TERMINALS" on page 20.
- 2** Set up of data communication settings.
For details, refer to "DATA COMMUNICATION (COMM)" on page 52.
- 3** Perform measurements.
- 4** Tap the  button of the control panel.
When output is completed, "DATA OUT" is displayed on the screen.

INPUT USING USB

This instrument can input ID numbers from a bar code reader, etc via the USB.

- 1** Check the connection of USB IN.
For connection, refer to "CONNECTING EXTERNAL I/O TERMINALS" on page 20.
- 2** Input ID numbers from the external device.
The inputted ID numbers are displayed on the screen.

OUTPUT USING LAN

This instrument can output data to a PC, etc via the LAN interface.

- 1** Connect the network cable to LAN OUT.
For connection, refer to "CONNECTING EXTERNAL I/O TERMINALS" on page 20.
- 2** Set up of LAN connection settings.
For details, refer to "LAN CONNECTION (LAN)" on page 53.
- 3** Perform measurements.
- 4** Tap the  button of the control panel.
When output is completed, "DATA OUT" is displayed on the screen.



For explanation of messages during communication refer to the "MESSAGE LIST" on page 54.

SETTING FUNCTIONS ON SETUP SCREEN

OPERATING THE SETUP SCREEN

Various functions can be set on the SETUP screen.

PREPARATONS FOR SETTING

- 1** Make sure that the power cable is connected.
For connection, refer to “CONNECTING POWER CABLE” on page 19.
- 2** Turn ON the (POWER) switch.
- 3** Tap the (SETTINGS) button on the control panel.

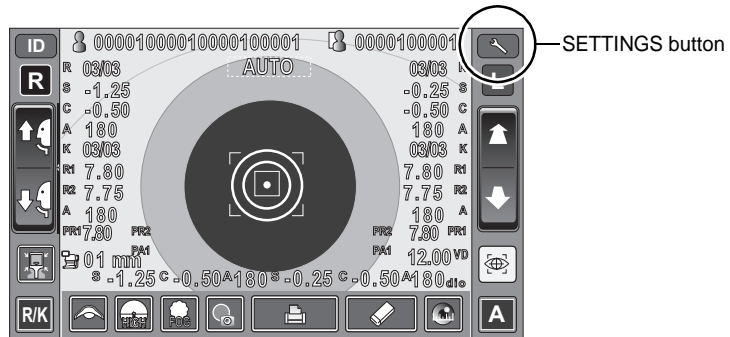

The SETUP screen is displayed.

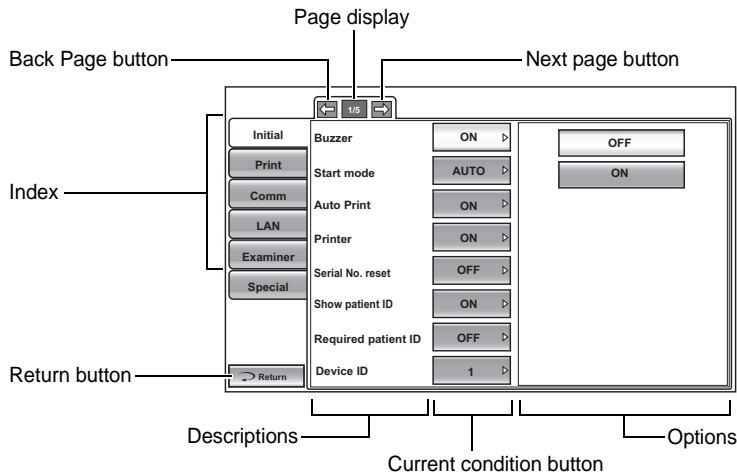

OUTLINE OF SETUP SCREEN OPERATIONS

- 1 Tap **INDEX** and select the subject of setting.

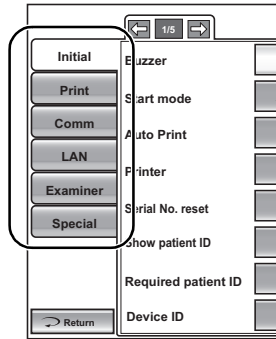

- 2 Operate the **NEXT PAGE** button or **BACK PAGE** button, as necessary, and display the page to confirm/change.

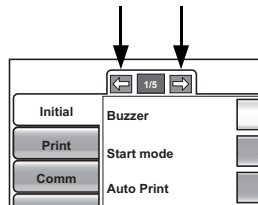

- 3 Tap the **CURRENT CONDITION** button of the item to be changed and find the **OPTIONS** button.

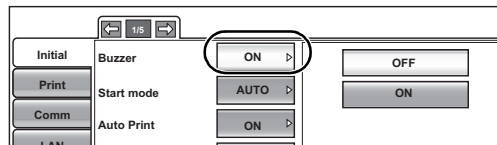

- 4 Tap the **OPTIONS** button and change the setting.

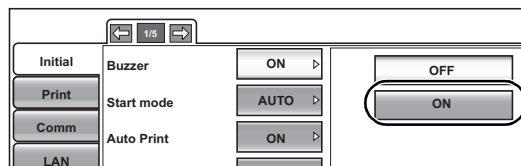

- Instead of the **OPTIONS** button, up/down buttons and ten-key would be displayed.

UP/DOWN BUTTON:

Tap up/down buttons on the screen and change setting.

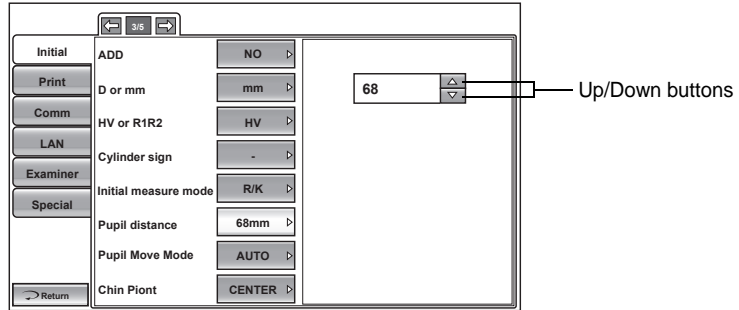

TEN-KEY:

Tap ten-key on the screen and enter the figure. If there are several windows to enter, tap the window to enter the figure by ten-key. Tap **OK** and fix the input value.

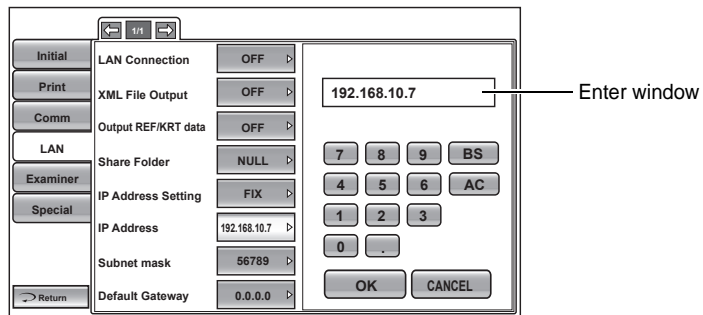

KEYBOARD:

Tap keyboard on the screen and enter characters. If there are several windows to enter, tap the window to enter the figure by keyboard. Tap **OK** and fix the input value.

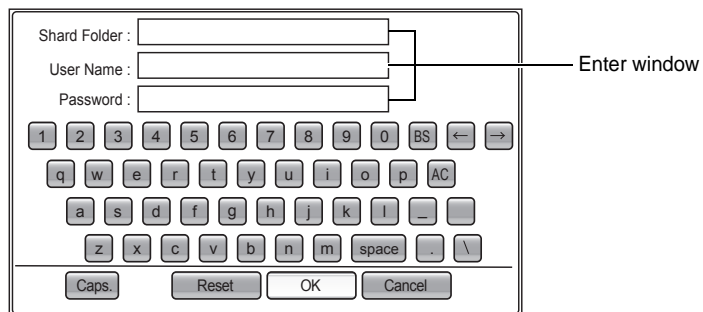

5 After changing all necessary settings, tap **RETURN** to update setting.

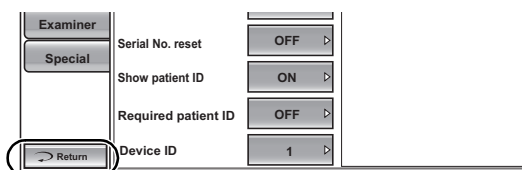

RETURNING TO THE MEASUREMENT SCREEN

1 Tap the **RETURN** button.

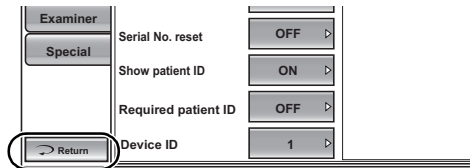

2 The Measurement screen is displayed.

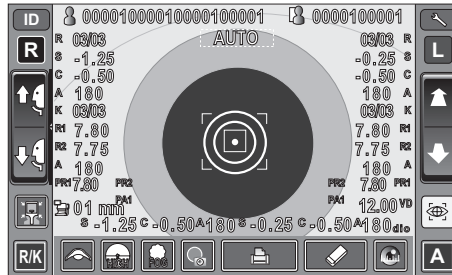

LIST OF SETUP ITEMS

Setup items are categorized into 6 large indexes.

- "Initial"items related to the initial status after power on
- "Print"items related to output from the internal printer
- "Comm"items related to data input/output with the external device
- "LAN"items related to input/output using the LAN
- "Examiner ID"items related to Examiner ID.
- "Special"items related to maintenance (for service engineer only)

INITIAL (INITIAL SETTING)

Initial contains settings related to the initial status after power on, clearing all measurement values, etc.

Descriptions	Options	Details	Initial value
Buzzer	OFF	Buzzer does not sound.	ON
	ON	Buzzer sounds.	
Start mode	MANUAL	Default measurement mode is MANUAL.	AUTO
	AUTO	Default measurement mode is AUTO.	
Auto print	ON	After AUTO measurement, results are printed out automatically.	ON
	OFF	Not printed automatically.	
Printer	OFF	Internal printer is disabled.	ON
	ON	Internal printer is active.	
Patient No. reset	OFF	Patient No. is not reset upon power on.	OFF
	ON	Patient No. is reset upon power on.	
Show patient ID	OFF	Patient ID is not displayed.	ON
	ON	Patient ID is displayed.	
Required patient ID	OFF	Patient ID is not displayed.	OFF
	ON	Patient ID is displayed.	
Device ID number	1-99 Set by ten-key display.	Sets the Device ID number	1
Show Device ID number.	OFF	Device ID is not required.	OFF
	ON	Device ID is required.	
Stand by mode	RIGHT	Waiting at the initial position for right eye measurement.	RIGHT
	LEFT	Waiting at the initial position for left eye measurement.	
	LAST	Waiting at the last position of the measured eye.	
Auto power save	OFF	Power save function is not used.	10min
	1min	Power save status in 1min after last operation.	
	5min	Power save status in 5min after last operation.	
	10min	Power save status in 10min after last operation.	
	20min	Power save status in 20min after last operation.	
	30min	Power save status in 30min after last operation.	
60min	Power save status in 60min after last operation.		
Cont. Cycle	1-10 Set by ten-key display	The number of continuous measurements	3
Continuous fog	EVERYTIME	Continuous fog is applied every time.	ONCE
	ONCE	Continuous fog is applied only once before the 1st measurement.	
Date/Time	Set by ten-key display.	Sets year, month, day, time (24hrs), minute and second	Installation date/time
Sph/Cyl step	0.12	Sph/Cyl is displayed by 0.12D step.	0.25
	0.25	Sph/Cyl is displayed by 0.25D step.	
Axis step	1°	Axial angle is displayed by 1° step	1°
	5°	Axial angle is displayed by 5° step	

Descriptions	Options	Details	Initial value
VD	0.00	VD value is set to 0mm (contact lens).	13.75
	12.00	VD value is set to 12.00mm (eyeglass lens).	
	13.75	VD value is set to 13.75mm (eyeglass lens).	
ADD	NO 40-44 45-49 50-54 55-59 60-64 65-69 70-74	The typical additional power for the age can be selected.	NO
D or mm(KRT)	D	D (diopter) of corneal refractive power	mm
	mm	mm of corneal curvature	
HV or R1R2	HV	Corneal curvature radius measurement result on screen is displayed by HV	R1R2
	R1R2	Corneal curvature radius measurement result on screen is displayed by R1R2	
Show KRT unit	OFF	KRT unit is not shown.	OFF
	ON	KRT unit is shown.	
Cylinder sign	+	Cylinder sign is "+".	-
	-	Cylinder sign is "-".	
	MIX	Cylinder sign is "+" and "-".	
Init. Measure Mode	REF	Default measurement mode on is REF.	REF/KRT
	REF/KRT	Default measurement mode is R/K.	
	KRT	Default measurement mode is KRT.	
Pupil distance	58mm 60mm 62mm 64mm 66mm 68mm 70mm 72mm 74mm Set by up/down button.	Sets the pupil distance between right and left eyes.	68
R/L move	Manual	Measurement head moves right and left manually.	Auto
	Auto	After selecting R/L, auto alignment for right/left and up/down is performed.	
R/L notation	R/L	Right/left eyes is displayed by R/L.	R/L
	OD/OS	Right/left eyes is displayed by OD/OS.	
Chin rest height	HIGH CENTER LOW	Default chinrest height.	LOW
Peripheral KRT	OFF	Peripheral KRT measurement is off.	OFF
	ON	Peripheral KRT measurement is on.	
Control panel brightness	Level 1 (dark)	The brightness of control panel.	Level 4
	Level 2		
	Level 3		
	Level 4 (bright)		
Picture printer	Normal Printer	Picture of refractive condition is not printed.	Normal Printer
	Graphic Printer	Picture of refractive condition is printed.	
REF ring display	OFF	REF ring is not displayed.	ON
	ON	REF ring is displayed.	
REF average	OFF	REF average is not displayed.	OFF
	ON	REF average is displayed.	
Packing mode	Start	Packing mode will start.	-
Model eye measure mode	Start	Model eye measurement mode will start.	-

Descriptions	Options	Details	Initial value
Shaded characters	ON	Font style of measurement values is shaded.	ON
	OFF	Font style of measurement values is not shaded.	

SETTING OF INTERNAL PRINTER (PRINT)

Print contains settings related to output from the internal printer.

	Description	Options	Details	Initial value
Preset	-	ALL	Print format of preset is ALL.	ALL
	-	AVE	Print format of preset is AVE.	
	-	CLASSIC	Print format of preset is CLASSIC.	
Common	Barcode	ON	Barcode is printed.	OFF
		OFF	Barcode is not printed.	
	Operator ID	ON	Operator ID is printed.	OFF
		OFF	Operator ID is not printed.	
	Name	ON	"Name" space is available.	ON
		OFF	"Name" space is not available.	
	Date	ON	Date is printed.	ON
		OFF	Date is not printed.	
	Date style	YMD	Print in Year/Month/Day format.	DMY
		MDY	Print in Month/Day/Year format.	
		DMY	Print in Day/Month/Year format.	
	Patient ID	ON	Patient ID is printed.	ON
		OFF	Patient ID is not printed.	
	KR number	ON	KR No. is printed.	OFF
		OFF	KR No. is not printed.	
	Serial number	ON	Serial No. is printed.	ON
		OFF	Serial No. is not printed.	
	ERROR data	ON	"Error" data is printed.	OFF
		OFF	"Error" data is not printed.	
	TOPCON logo	ON	TOPCON logo is printed.	ON
		OFF	TOPCON logo is not printed.	
Message	ON	Message is printed.	OFF	
	OFF	Message is not printed.		
Message data	Set by key-board display	String of up to 72 characters.	NONE	
Between the lines	0-24 Set by ten key display	Line space is set in dot units.	0	

	Description	Options	Details	Initial value
REF/KRT (Print setting on R/K mode)	Print order	R/K	Measurement values are printed in terms of REF or KRT.	R/K
		R/L	Measurement values are printed in terms of Right or Left.	
	VD	ON	VD value is printed.	ON
		OFF	VD values is not printed.	
	Cylinder sign	ON	Cylinder sign is printed.	ON
		OFF	Cylinder sign is not printed.	
	REF format	ALL	All refractive measurements are printed.	ALL
		AVE	Only averaged is printed.	
	Credibility	OFF	Credibility number is not printed.	OFF
		ON	Credibility number is printed.	
	S.E.	ON	S.E. is printed.	ON
		OFF	S.E.is not printed.	
	PD	ON	PD values is printed.	ON
		OFF	PD value is not printed.	
	ADD	ON	ADD value is printed.	OFF
		OFF	ADD value is not printed.	
	KRT print order	D/mm	KRT data is printed as follows, D(diopter) / mm(milimeter).	D/mm
		mm/D	KRT data is printed as follows, mm(milimeter)/D(diopter).	
	KRT format	ALL	All measurement values are printed.	ALL
		AVE	Only typical value are printed.	
	KRT style	HV	Kerato style in print out is HV (horizontal/vertical).	R1R2
		R1R2	Kerato style in print out is R1R2 (flat/steep meridian).	
	KRT print format	HV	KRT measurement result is printed in simple format.	Simple
		R1R2	KRT measurement result is printed in full format.	
KRT average	ON	KRT average value is printed.	ON	
	OFF	KRT average value is not printed.		
KRT cylinder	ON	kerato-cylinder value and axial angle are printed.	ON	
	OFF	Kerato-cylinder value and axial angle are printed.		
Corneal diameter	ON	Corneal diameter is printed.	ON	
	OFF	Corneal diameter is not printed.		
REF (Print setting on REF mode)	Print order	R/K	Measurement values are printed in terms of REF or KRT.	R/K
		R/L	Measurement values are printed in terms of Right or Left.	
	VD	ON	VD value is printed.	ON
		OFF	VD values is not printed.	
	Cylinder sign	ON	Cylinder sign is printed.	ON
		OFF	Cylinder sign is not printed.	
	REF format	ALL	All refractive measurements are printed.	ALL
		AVE	Only averaged is printed.	
	Credibility	OFF	Credibility number is not printed.	OFF
		ON	Credibility number is printed.	
	S.E.	ON	S.E. is printed.	ON
		OFF	S.E.is not printed.	
	PD	ON	PD values is printed.	ON
		OFF	PD value is not printed.	
	ADD	ON	ADD value is printed.	OFF
		OFF	ADD value is not printed.	

	Description	Options	Details	Initial value
KRT (Print setting on KRT mode)	KRT print order	D/mm	Printed in order of D (diopter) and mm (millimeter).	D/mm
		mm/D	Printed in order of mm (millimeter) and D (diopter)	
	KRT format	ALL	Printout all measurement values.	ALL
		AVE	Printout only typical value.	
	KRT type	HV	Display style of KRT measurement results is set to HV (horizontal/vertical).	R1R2
		R1R2	Display style of KRT measurement results is set to R1R2 (flat/steep meridian).	
	KRT format detail	HV	KRT measurement result is printed in simple format.	Simple
		R1R2	KRT measurement result is printed in full format.	
	KRT average	ON	Print KRT average value.	ON
		OFF	Do not print KRT average value.	
	KRT cylinder	ON	Print kerato-cylinder value and axial angle.	ON
		OFF	Do not print kerato-cylinder value and axial angle.	
Corneal diameter	ON	Print corneal diameter.	ON	
	OFF	Do not print corneal diameter.		

DATA COMMUNICATION (COMM)

Comm contains settings related to data input/output with the external device.

Description	Options	Details	Initial value
Output Data	REF	Only REF data are output.	ALL
	KRT	Only KRT data are output.	
	ALL	All data are output.	
Format	OLD	OLD TOPCON format	OLD
	NEW	NEW TOPCON format	
	STD1	TOPCON STD1 format	
	STD2	TOPCON STD2 format	
	STD4	TOPCON STD4 format	
Output port	OFF	RS-232C port is disabled.	OFF
	ON	RS-232C port is enabled.	
Baudrate	2400	Baudrate value:2400	2400
	9600	Baudrate value:9600	
	USB	USB	

LAN CONNECTION (LAN)

LAN contains settings related to data input/output via LAN.

Description	Options	Details	Initial value
LAN Connection	ON	LAN connection is on.	OFF
	OFF	LAN connection is off.	
XML File Output	ON	XML file is output.	OFF
	OFF	XML file is not output.	
REF/KRT Data format	OFF	REF/KRT data file is not output.	OFF
	STD2	REF/KRT data are output in TOPCON STD2 format	
	STD4	REF/KRT data are output in TOPCON STD4 format	
Shared Folder Setting	Shared folder (up to 32 characters) User name (up to 32 characters) Password (up to 16 characters) Set by keyboard display	Path and permission to shared folder is set.	NONE
IP Address Setting	FIX	Assign IP address manually.	FIX
	AUTO	Assign IP address automatically.	
IP Address	0. 0. 0. 0 Set by ten-key display	IP address of PC to output data.	NONE
Subnet Mask	0. 0. 0. 0 Set by ten-key display	Subnet mask address of KR-1.	NONE
Default Gateway	0. 0. 0. 0 Set by ten-key display	Default gateway address of KR-1.	NONE
Primary DNS Server	0. 0. 0. 0 Set by ten-key display	Primary DNS Server number.	NONE
Secondary DNS Server	0. 0. 0. 0 Set by ten-key display	Secondary DNS Server number.	NONE

OPERATOR ID

OPERATOR contains settings related to Operator ID.

Description	Options	Details	Initial value
Use Operator ID	ON	Operator ID will be displayed on the control panel and output.	OFF
	OFF	Operator ID will not be displayed on the control panel and output.	
Prefix of Operator ID	Set by ten-key display (up to 3 characters)	Set the Prefix of Operator ID can be registered.	NONE
Operator ID request	OFF	Operator ID is not required.	OFF
	ON	Operator ID is required.	
Fixed operator ID	OFF	Operator ID is not fixed.	OFF
	ON	Operator ID is fixed.	
Input Fixed operator ID	Set by ten-key display (up to 21 characters)	Input fixed operator ID	NONE

SPECIAL

SPECIAL is the mode for service engineer only; it can not be accessed.

TROUBLESHOOTING

MESSAGE LIST

"OVER-SPH"	Spherical power exceeds +22D or -25D.
"OVER-CYL"	Cylindrical power exceeds $\pm 10D$.
"OVER-R"	Corneal curvature exceeds 5.00-10.00mm.
"NO TARGET"	There is no target or the eye image is too dark.
"AGAIN"	There is more than 5D difference from the previous measurement value.
"NO CENTER"	Center of eye can not be found.
"ALIGN ERR"	Alignment significantly failed during the measurement.
"ERROR"	The patient's eye blinks or moves during measurement. If this message appears while with measuring model eye, the instrument may have a problems. Contact your service engineer.
"LAN hostname Error"	Failed in host name resolution of the destination (to be connected with the share folder). Confirm the inputted host name or DNS server address.
"LAN mount Error"	Failed in connection with the share folder. Confirm the address, folder name, user name and password of the destination (to be connected with the share folder).
"LAN create Error"	Failed in file creation. Confirm that write permission to the share folder is set correctly.
"LAN write Error"	Failed in writing to the file. Confirm that write permission to the share folder is set correctly. Also, check whether or not the share folder is accessed by another program.
"RS232C FAIL"	Failed in RS232C data transmission.
"Please check the DATE/TIME"	The battery for the built-in clock become run down. Before using, confirm the time and date on the SETUP menu. If the message comes up frequently, call your service engineer.

TROUBLE-SHOOTING OPERATIONS



WARNING

To avoid electrical shock, do not open the instrument. All service should be performed by a qualified service engineer.

If a problem is suspected, use the following check list.

If following instructions does not improve the condition, or if your problem is not included in the list, contact your dealer or TOPCON at the address on the back cover.

CHECK LIST

Trouble	Condition	Check	Page
Control panel does not turn on.	—————	Is power cable unplugged?	19
		Is power cable connected to the instrument?	19
	Fuse blows when power switch is turned on.	Call our service engineer.	68
Control panel is not clear.	The image is dark.	Adjust the brightness by "Control panel Brightness Adjust".	49
Any trouble is found in a movable part.	—————	Do not move it forcibly but call our service engineer.	28
Printing is not done.	Paper comes out without printing.	Confirm the direction of paper winding. If the direction is incorrect, reset paper to the proper direction.	21
	Paper does not come out.	If "PAPER END" displayed on control panel, replenish printer paper.	21

ENVIRONMENTAL CONDITIONS

ENVIRONMENTAL CONDITIONS OF USE

Temperature: +10°C to + 40°C
Humidity: 30% to 90% RH(without condensation)
Atmospheric pressure: 700hPa to 1060hPa

ENVIRONMENTAL CONDITIONS OF STORAGE

(Product unprotected, ready for operation, power supply not connected)

*Temperature: +10 °C to + 40 °C
Humidity: 10% to 95% (without condensation)
Atmospheric pressure: 700hPa to 1060hPa

***THIS INSTRUMENT DOES NOT MEET THE TEMPERATURE REQUIREMENTS OF ISO 15004-1 FOR STORAGE.**

DO NOT STORE THIS INSTRUMENT IN CONDITIONS WHERE THE TEMPERATURE MAY RISE ABOVE 40°C OR FALL BELOW 10°C.

ENVIRONMENTAL CONDITIONS OF STORAGE

(Product in its normal transport and storage container as provided by manufacturer)

Temperature : -20°C to + 50°C
Humidity : 10% to 95%

ENVIRONMENTAL CONDITIONS OF TRANSPORT

(Product in its normal transport and storage container as provided by manufacturer)

Temperature: : -40°C to + 70°C
Humidity: : 10% to 95%

ELECTROMAGNETIC COMPATIBILITY

The product conforms to the EMC standard (IEC 60601-1-2 Ed3.0:2007)

- a) MEDICAL ELECTRICAL EQUIPMENT needs special precautions regarding EMC and needs to be installed and put into service according to the EMC information provided in the ACCOMPANYING DOCUMENTS.
- b) Portable and mobile RF communications equipment can affect MEDICAL ELECTRICAL EQUIPMENT.
- c) The use of ACCESSORIES, transducers and cables other than those specified, with the exception of transducers and cables sold by the manufacturer of the EQUIPMENT or SYSTEM as replacement parts for internal components, may result in increased EMISSIONS or decreased IMMUNITY of the EQUIPMENT or SYSTEM.
- d) The EQUIPMENT or SYSTEM should not be used adjacent to or stacked with other equipment. If adjacent or stacked use is necessary, the EQUIPMENT or SYSTEM should be observed to verify normal operation in the configuration in which it will be used.
- e) The use of the ACCESSORY, transducer or cable with EQUIPMENT and SYSTEMS other than those specified may result in increased EMISSION or decreased IMMUNITY of the EQUIPMENT or SYSTEM.

Guidance and manufacturer's declaration - electromagnetic emissions		
The KR-1 is intended for use in the electromagnetic environment specified below. The customer or the user of the KR-1 should assure that it is used in such an environment.		
Emissions test	Compliance	Electromagnetic environment - guidance
RF emissions CISPR 11	Group 1	The KR-1 uses RF energy only for its internal function. Therefore, its RF emissions are very low and are not likely to cause any interference in nearby electronic equipment. The KR-1 is suitable for use in all establishments other than domestic and those directly connected to the public low-voltage power supply network that supplies buildings used for domestic purposes.
RF emissions CISPR 11	Class B	
Harmonic emissions IEC61000-3-2	Complies	
Voltage fluctuations/ flicker emissions IEC61000-3-3	Complies	

Guidance and manufacturer's declaration - electromagnetic immunity

The KR-1 is intended for use in the electromagnetic environment specified below. The customer or the user of the KR-1 should assure that it is used in such an environment.

Immunity test	IEC 60601 test level	Compliance level	Electromagnetic environment - guidance
Electrostatic discharge(ESD) IEC 61000-4-2	± 6 kV contact ± 8 kV air	± 6 kV contact ± 8 kV air	Floors should be wood, concrete or ceramic tile. If floors are covered with synthetic material, the relative humidity should be at least 30%.
Electrical fast transient/burst IEC 61000-4-4	± 2 kV for power supply lines ± 1 kV for input/output lines	± 2 kV for power supply lines ± 1 kV for input/output lines	Mains power quality should be that of a typical commercial or hospital environment.
Surge IEC 61000-4-5	± 1 kV line(s) to line(s) ± 2 kV line(s) to earth	± 1 kV line(s) to line(s) ± 2 kV line(s) to earth	Mains power quality should be that of a typical commercial or hospital environment.
Voltage dips, short interruptions and Voltage variations on power supply input lines IEC 61000-4-11	<5% U_t (>95% dip in U_t) for 0, 5 cycle 40% U_t (60% dip in U_t) for 5 cycles 70% U_t (30% dip in U_t) for 25 cycles <5% U_t (>95% dip in U_t) for 5 sec.	<5% U_t (>95% dip in U_t) for 0, 5 cycle 40% U_t (60% dip in U_t) for 5 cycles 70% U_t (30% dip in U_t) for 25 cycles <5% U_t (>95% dip in U_t) for 5 sec.	Mains power quality should be that of a typical commercial or hospital environment. If the user or the KR-1 requires continued operation during power mains interruptions, it is recommended that the KR-1 be powered from an uninterruptible power supply or battery.
Power frequency (50/60 Hz) magnetic field IEC 61000-4-8	3 A/m	3 A/m	Power frequency magnetic fields should be at levels characteristic of a typical location in a typical commercial or hospital environment.

NOTE U_t is the a.c. mains voltage prior to application of the test level.

Guidance and manufacturer's declaration - electromagnetic immunity

The KR-1 is intended for use in the electromagnetic environment specified below.
The customer or the user of the KR-1 should assure that it is used in such an environment.

Immunity test	IEC 60601 test level	Compliance level	Electromagnetic environment - guidance
<p>Conducted RF IEC 61000-4-6</p> <p>Radiated RF IEC 61000-4-3</p>	<p>3 Vrms 150kHz to 80MHz</p> <p>3 V/m 80MHz to 2, 5GHz</p>	<p>3 V</p> <p>3 V/m</p>	<p>Portable and mobile RF communications equipment should be used no closer to any part of the KR-1, including cables, than the recommended separation distance calculated from the equation applicable to the frequency of the transmitter.</p> <p>Recommended separation distance</p> $d = 1.2 \sqrt{P}$ <p>$d = 1.2 \sqrt{P}$ 80MHz to 800MHz</p> <p>$d = 2.3 \sqrt{P}$ 800MHz to 2, 5GHz</p> <p>where P is the maximum output power rating of the transmitter in watts (W) according to the transmitter manufacturer and d is the recommended separation distance in meters (m).</p> <p>Field strengths from fixed RF transmitters, as determined by an electromagnetic site survey,^a should be less than the compliance level in each frequency range.^b</p> <p>Interference may occur in the vicinity of equipment marked with the following symbol:</p> <div style="text-align: center;">  </div>
NOTE 1	At 80 MHz and 800 MHz, the higher frequency range applies.		
NOTE 2	These guidelines may not apply in all situations. Electromagnetic propagation is affected by absorption and reflection from structures, objects and people.		
a	Field strengths from fixed transmitters, such as base stations for radio (cellular/cordless) telephones and land mobile radios, amateur radio, AM and FM radio broadcast and TV broadcast cannot be predicted theoretically with accuracy. To assess the electromagnetic environment due to fixed RF transmitters, an electromagnetic site survey should be considered. If the measured field strength in the location in which the KR-1 is used exceeds the applicable RF compliance level above, the KR-1 should be observed to verify normal operation. If abnormal performance is observed, additional measures may be necessary, such as reorienting or relocating the KR-1.		
b	Over the frequency range 150 kHz to 80 MHz, field strengths should be less than 3 V/m.		

**Recommended separation distance between
portable and mobile RF communications equipment and the KR-1**

The KR-1 is intended for use in an electromagnetic environment in which radiated RF disturbances are controlled. The customer or the user of the KR-1 can help prevent electromagnetic interference by maintaining a minimum distance between portable and mobile RF communications equipment (transmitters) and the KR-1 as recommended below, according to the maximum output power of the communications equipment.

Rated maximum output power of transmitter W	Separation distance according to frequency of transmitter		
	150kHz to 80MHz $d = 1.2 \sqrt{P}$	80MHz to 800MHz $d = 1.2 \sqrt{P}$	800MHz to 2,5GHz $d = 2.3 \sqrt{P}$
0, 01	0, 12	0, 12	0, 23
0, 1	0, 38	0, 38	0, 73
1	1.2	1.2	2.3
10	3.8	3.8	7.3
100	12	12	23

For transmitters rated at a maximum output power not listed above, the recommended separation distance d in metres (m) can be estimated using the equation applicable to the frequency of the transmitter, where P is the maximum output power rating of the transmitter in watts (W) according to the transmitter manufacturer.

NOTE 1
NOTE 2

At 80 MHz and 800 MHz, the separation distance for the higher frequency range applies.
These guidelines may not apply in all situations. Electromagnetic propagation is affected by absorption and reflection from structures, objects and people.

ELECTRIC RATING

Source voltage: 100-240V AC, 50-60Hz

Power input: 75VA

SAFETY DESIGNATIONS PER IEC 60601-1 STANDARD

- Type of protection against electric shocks: Class I
The Class I equipment provides means to connect itself to the protective grounding system of utilities to thereby independently provide protection against electric shocks by keeping connectable metal components nonconductive in case of a failure in the basic insulation.
- Degree of protection against electric shocks: B type applied component
The B type applied component provides the specified degree of protection against electric shocks with regard to the reliability particularly of leak current, patient measuring current and protective utility connection (in case of Class I equipment).
- Degree of protection against harmful intrusion of water (IEC 60529): IPX0
This product does not provide protection against intrusion of water.
(The degree of protection against harmful ingress of water defined in IEC 60529 is IPX0)
- Classification by sterilization/disinfection method specified by manufacturer
This product does not have a component requiring sterilization/disinfection.
- Classification by safety of use in air/flammable anesthetic gas, oxygen or nitrous oxide/flammable anesthetic gas atmosphere
 - Equipment not suited for use in air/flammable anesthetic gas, oxygen or nitrous oxide/flammable anesthetic gas atmosphere
 - This product should be used in an environment free of flammable anesthetic gas and other flammable gases.
- Classification by operation mode
Continuous operation refers to an operation under normal load conditions, within the specified temperature and without limitations on the operating time.

DIMENSIONS AND WEIGHT

Dimensions: 286~326mm(W) × 445~526mm(D) × 466~615mm(H)

Weight : 19.0kg

OPERATION AND PRINCIPLE OF OPERATION

Refraction (REF)

The instrument projects a near infra red ring of light onto the retina and the reflection of the ring is captured by a CCD camera. An internal computer analyzes the image and calculates the spherical, cylindrical and axial values.

Keratometry (KRT)

The instrument projects a near infra red ring of light onto the cornea and the reflection of the ring is captured by a CCD camera. An internal computer analyzes the image and calculates the curvature radius, corneal astigmatic axis and the corneal refractive values.

The KR-1 projects a luminous flux (near-infrared light) for refractive measurement to retina, the reflected image is received by a CCD camera, and the spherical refractive power, cylindrical refractive power and the axis of astigmatism are determined through computation.

The KR-1 performs corneal curvature measurements by projecting a kerato-ring to the cornea, which receives the reflected image by a CCD camera from the cornea surface, and determines the curvature radius, corneal astigmatic axis angle and the corneal refractive power.

REFERENCE

OPTIONAL ACCESSORIES

- Adjustable instrument table AIT-16
The table height can be adjusted to facilitate measurement.

Specifications

- Dimensions525(W)x490(D)mm
 - Table height.....660~880mm
 - Table size490x500mm
 - Weight.....approx. 23kg
 - Power consumption ..150VA (100-120V, 220-240V)
- RS232C on-line cable

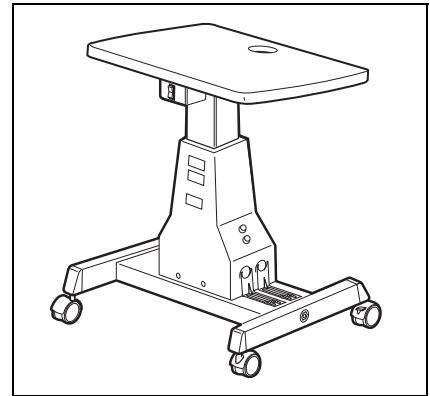

SHAPE OF PLUG

Country	Voltage/frequency	Shape of plug
Mexico	110V/50Hz	Type C&E
Argentina	220V/60Hz	Type A
Peru	220V/60Hz	Type A
Venezuela	110V/50Hz	Type C&E
Bolivia & Paraguay	220V/60Hz	Type A (Most common) Type H (Infrequently)
Chile	220V/60Hz	Type A
Colombia	110V/50Hz	Type C
Brazil	220V/60Hz 127V/60Hz	Type A Type C
Ecuador	110V/50Hz	Type C&E
USA	120V/60Hz	Type A (Hospital Grade)
Canada	120V/60Hz	Type A (Hospital Grade)

SYMBOL

Symbol	IEC/ISO Publication	Description	Description (French)
	IEC 60417-5032	Alternating Current	Courant alternatif
	IEC 60417-5008	Off (power: disconnection from the main power supply)	Éteint (courant: coupure avec le secteur)
	IEC 60417-5007	On (power: connection to the main power supply)	Allumé (courant: raccordement sur le secteur)
	IEC 60878-02-02	Type B applied part	Partie appliquée du Type B
	ISO 7010-W001	General warning sign	Symbole d'avertissement général

MAINTENANCE

DAILY CHECKUPS

CHECKING THE MEASURING ACCURACY

- The attached model eye should be measured and the accuracy checked at regular intervals.
- To set up the model eye, insert the guide groove of the model eye to the chinrest tissue pin.
- Set the display step of spherical/cylindrical to 0.12D and perform measurement.

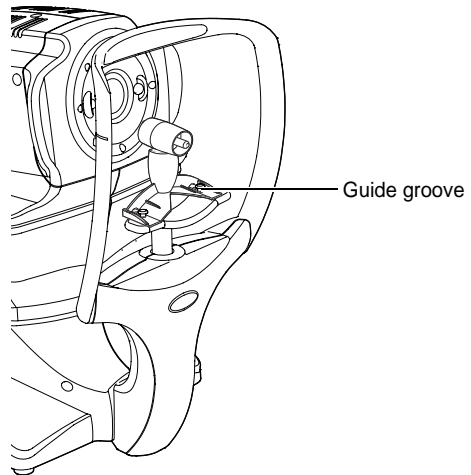

If the measurement result is widely different from the value shown on the model eye, call your dealer or TOPCON at the address on back cover.

CLEANING THE INSTRUMENT

NOTE:	To ensure correct measurement, do not touch a light source for Peripheral KRT measurement.
--------------	--

- Dust on measuring window Blow off dust with a blower.
- Dust on a light source for Peripheral KRT measurement Blow off dust by a blower. To ensure correct measurement, do not touch a light source for Peripheral KRT measurement.

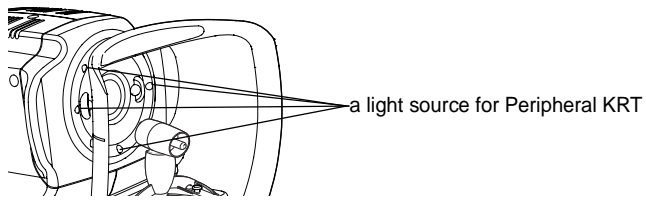

- Fingerprints and oil spots on measuring window Blow off dust by a blower and wipe the surface gently with a camera lens cleaner using clean gauze.
- Dirty instrument cover Wipe the surface with the attached silicon cloth or a dry soft cloth. Never use solvents or a chemical duster.

CLEANING THE FOREHEAD REST AND CHIN REST

- Wipe the forehead rest and the chin rest with a cloth moistened with a tepid solution of neutral detergent for kitchenware.

DAILY MAINTENANCE

- For this instrument, dust may cause errors. When not in use, replace the measuring lens cap and dust cover.
- When not in use, turn off the POWER switch.



When using the dust cover, tap the Reset button and return the chinrest and measuring head to their initial positions.

ORDERING CONSUMABLE ITEMS

- When ordering consumable items, tell the product name, product code and quantity to your dealer or TOPCON at the address of back cover.

Product name	Product code
Chinrest tissue	40310 4082
Silicon cloth	44800 1001
Dust cover	42360 9002

Product name	Product code
Printer paper	44800 4001
Fuse T 3AL 250V	T2400 0158A

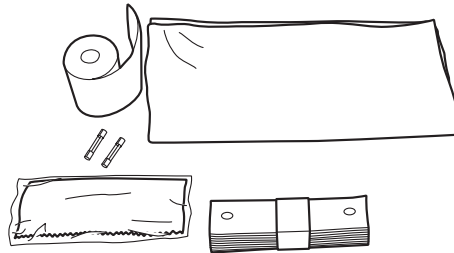



USER MAINTENANCE ITEM

Item	Inspection time	Contents
Inspection	Before using	<ul style="list-style-type: none"> • The instrument works properly. • The objective lens must be free of stain or flaw.
Cleaning	When the part is stained	<ul style="list-style-type: none"> • Objective lens • External cover, control panel, etc.
Replacement	As required	<ul style="list-style-type: none"> • Fuse

BRIGHTNESS ADJUSTMENT OF CONTROL PANEL

- The control panel is optimally adjusted when shipped.
- For control panel brightness adjustment, see "INITIAL (INITIAL SETTING)," "Control panel brightness" (page 49).

PRINTER PAPER JAM

 CAUTION	To avoid failure or potential injury, do not open the printer cover while the printer is in operation.
 CAUTION	To avoid potential injury in case of malfunction, including a paper jam, be sure to shut off the power before attempting to repair it.
 CAUTION	To avoid potential injury, do not touch the printer body including metal parts or the paper cutter, while the printer is in operation or when replacing the printer paper.
NOTE:	<ul style="list-style-type: none">• If the printer paper is jammed in the printer, printing will stop and the jam should be cleared.

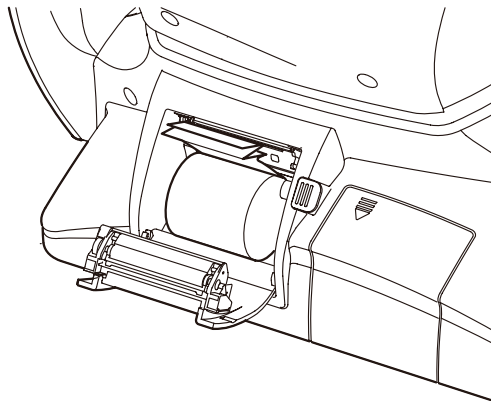

- 1 Open the printer cover, and take out the jammed paper pieces with the paper retainer lever fully released.



After removing the jammed printer paper, tap the Print button to print out the previous measurement data.

If no previous measurement data has saved, a blank sheet is printed out.

FUSE CHANGE

 WARNING	To avoid electric shocks during fuse change, be sure to unplug the power cable before removing the fuse lid. Also, do not plug the power cable with the fuse lid removed.
 WARNING	Always use the attached fuse (T 3AL 250V). Using any other type may cause malfunction and fire.

- 1** Make sure the power is off and the power cable is unplugged.
- 2** Tilt the body slowly so that the power switch comes up and the power inlet at the bottom can be seen.
- 3** Press the fuse holder with a screwdriver and turn it counter-clockwise. The fuse holder can be taken out.

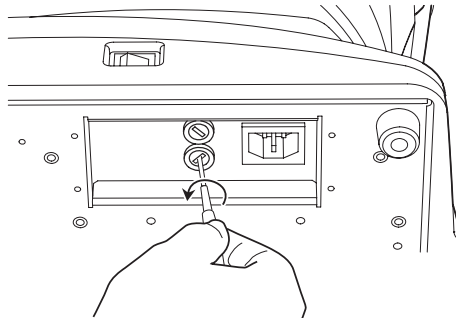

- 4** Replace the fuse with a spare one.

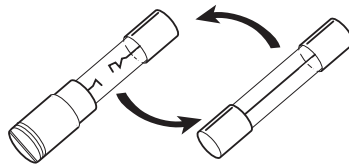

Replacing the fuse

- 5** Press the fuse holder lightly with a screwdriver and turn it clockwise. The fuse holder is set.

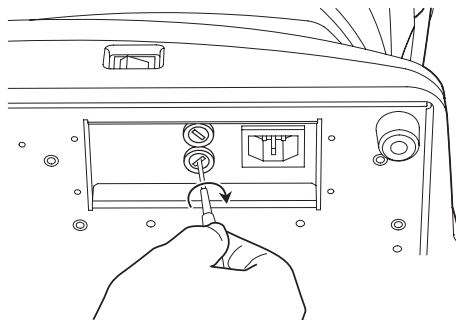

SUPPLYING THE CHINREST TISSUE

- When the chinrest tissue has run out, pull off chinrest tissue pins and place new tissue.

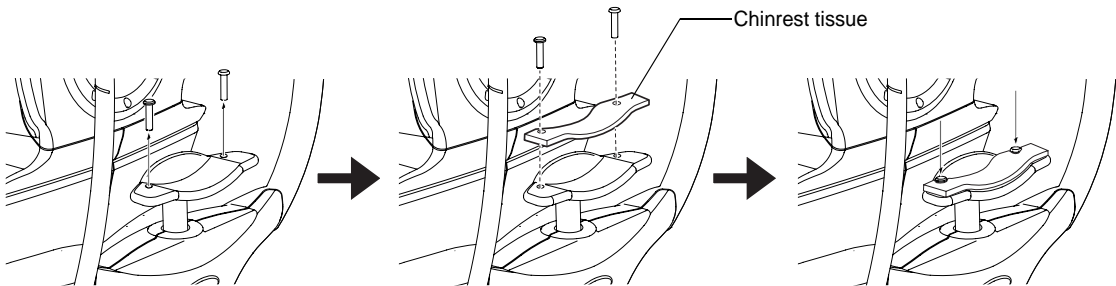
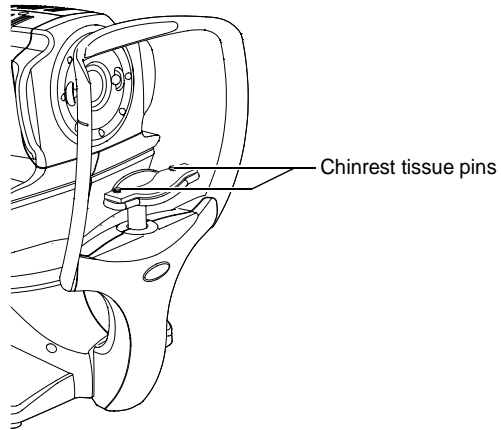

MAINTENANCE

CLEANING THE COVER

NOTE:	Do not clean plastic parts with solvents. Benzine, thinner, ether and gasoline may cause discoloring and decomposition.
--------------	---

- 1** If the cover, control panel, etc. get soiled, wipe the surface with dry cloth.
- 2** If the cover is noticeably stained, wipe the surface with a damp cloth which is moistened in a tepid water solution of neutral detergent.

CLEANING THE CONTROL PANEL

NOTE:	As the control panel screen is a touch panel, be sure to turn off the POWER switch before wiping. The touch panel will react and malfunction.
--------------	---

NOTE:	When the monitor cleaner has become dirty, wash it. When washing, rinse it thoroughly so no detergent is left. If the detergent is left, it may cause uneven wiping.
--------------	--

CONTAMINATION BY DUST

Remove the dust with a soft brush, and wipe with the attached monitor cleaner.

CONTAMINATION BY FINGERPRINTS

Wipe with the attached monitor cleaner.

If the stain still remains, moisten the monitor cleaner with water and then wipe off the stain.

IPA FONT LICENSE AGREEMENT V1.0

The Licensor provides the Licensed Program (as defined in Article 1 below) under the terms of this license agreement ("Agreement"). Any use, reproduction or distribution of the Licensed Program, or any exercise of rights under this Agreement by a Recipient (as defined in Article 1 below) constitutes the Recipient's acceptance of this Agreement.

Article 1 (Definitions)

1. "Digital Font Program" shall mean a computer program containing, or used to render or display fonts.
2. "Licensed Program" shall mean a Digital Font Program licensed by the Licensor under this Agreement.
3. "Derived Program" shall mean a Digital Font Program created as a result of a modification, addition, deletion, replacement or any other adaptation to or of a part or all of the Licensed Program, and includes a case where a Digital Font Program newly created by retrieving font information from a part or all of the Licensed Program or Embedded Fonts from a Digital Document File with or without modification of the retrieved font information.
4. "Digital Content" shall mean products provided to end users in the form of digital data, including video content, motion and/or still pictures, TV programs or other broadcasting content and products consisting of character text, pictures, photographic images, graphic symbols and/or the like.
5. "Digital Document File" shall mean a PDF file or other Digital Content created by various software programs in which a part or all of the Licensed Program becomes embedded or contained in the file for the display of the font ("Embedded Fonts"). Embedded Fonts are used only in the display of characters in the particular Digital Document File within which they are embedded, and shall be distinguished from those in any Digital Font Program, which may be used for display of characters outside that particular Digital Document File.
6. "Computer" shall include a server in this Agreement.
7. "Reproduction and Other Exploitation" shall mean reproduction, transfer, distribution, lease, public transmission, presentation, exhibition, adaptation and any other exploitation.
8. "Recipient" shall mean anyone who receives the Licensed Program under this Agreement, including one that receives the Licensed Program from a Recipient.

Article 2 (Grant of License)

The Licensor grants to the Recipient a license to use the Licensed Program in any and all countries in accordance with each of the provisions set forth in this Agreement. However, any and all rights underlying in the Licensed Program shall be held by the Licensor. In no sense is this Agreement intended to transfer any right relating to the Licensed Program held by the Licensor except as specifically set forth herein or any right relating to any trademark, trade name, or service mark to the Recipient.

1. The Recipient may install the Licensed Program on any number of Computers and use the same in accordance with the provisions set forth in this Agreement.
2. The Recipient may use the Licensed Program, with or without modification in printed materials or in Digital Content as an expression of character texts or the like.
3. The Recipient may conduct Reproduction and Other Exploitation of the printed materials and Digital Content created in accordance with the preceding Paragraph, for commercial or non-commercial purposes and in any form of media including but not limited to broadcasting, communication and various recording media.
4. If any Recipient extracts Embedded Fonts from a Digital Document File to create a Derived Program, such Derived Program shall be subject to the terms of this agreement.
5. If any Recipient performs Reproduction or Other Exploitation of a Digital Document File in which Embedded Fonts of the Licensed Program are used only for rendering the Digital Content within such Digital Document File then such Recipient shall have no further obligations under this Agreement in relation to such actions.
6. The Recipient may reproduce the Licensed Program as is without modification and transfer such copies, publicly transmit or otherwise redistribute the Licensed Program to a third party for commercial or non-commercial purposes ("Redistribute"), in accordance with the provisions set forth in Article 3 Paragraph 2.
7. The Recipient may create, use, reproduce and/or Redistribute a Derived Program under the terms stated above for the Licensed Program: provided, that the Recipient shall follow the provisions set forth in Article 3 Paragraph 1 when Redistributing the Derived Program.

Article 3 (Restriction)

The license granted in the preceding Article shall be subject to the following restrictions:

1. If a Derived Program is Redistributed pursuant to Paragraph 4 and 7 of the preceding Article, the following conditions must be met :
 - (1)The following must be also Redistributed together with the Derived Program, or be made available online or by means of mailing mechanisms in exchange for a cost which does not exceed the total costs of postage, storage medium and handling fees:
 - (a)a copy of the Derived Program; and
 - (b)any additional file created by the font developing program in the course of creating the Derived Program that can be used for further modification of the Derived Program, if any.
 - (2)It is required to also Redistribute means to enable recipients of the Derived Program to replace the Derived Program with the Licensed Program first released under this License (the "Original Program"). Such means may be to provide a difference file from the Original Program, or instructions setting out a method to replace the Derived Program with the Original Program.
 - (3)The Recipient must license the Derived Program under the terms and conditions of this Agreement.
 - (4)No one may use or include the name of the Licensed Program as a program name, font name or file name of the Derived Program.
 - (5) Any material to be made available online or by means of mailing a medium to satisfy the requirements of this paragraph may be provided, verbatim, by any party wishing to do so.
2. If the Recipient Redistributes the Licensed Program pursuant to Paragraph 6 of the preceding Article, the Recipient shall meet all of the following conditions:
 - (1)The Recipient may not change the name of the Licensed Program.
 - (2)The Recipient may not alter or otherwise modify the Licensed Program.
 - (3)The Recipient must attach a copy of this Agreement to the Licensed Program.

3. THIS LICENSED PROGRAM IS PROVIDED BY THE LICENSOR "AS IS" AND ANY EXPRESSED OR IMPLIED WARRANTY AS TO THE LICENSED PROGRAM OR ANY DERIVED PROGRAM, INCLUDING, BUT NOT LIMITED TO, WARRANTIES OF TITLE, NON-INFRINGEMENT, MERCHANTABILITY, OR FITNESS FOR A PARTICULAR PURPOSE, ARE DISCLAIMED. IN NO EVENT SHALL THE LICENSOR BE LIABLE FOR ANY DIRECT, INDIRECT, INCIDENTAL, SPECIAL, EXTENDED, EXEMPLARY, OR CONSEQUENTIAL DAMAGES (INCLUDING, BUT NOT LIMITED TO; PROCUREMENT OF SUBSTITUTED GOODS OR SERVICE; DAMAGES ARISING FROM SYSTEM FAILURE; LOSS OR CORRUPTION OF EXISTING DATA OR PROGRAM; LOST PROFITS), HOWEVER CAUSED AND ON ANY THEORY OF LIABILITY, WHETHER IN CONTRACT, STRICT LIABILITY OR TORT (INCLUDING NEGLIGENCE OR OTHERWISE) ARISING IN ANY WAY OUT OF THE INSTALLATION, USE, THE REPRODUCTION OR OTHER EXPLOITATION OF THE LICENSED PROGRAM OR ANY DERIVED PROGRAM OR THE EXERCISE OF ANY RIGHTS GRANTED HEREUNDER, EVEN IF ADVISED OF THE POSSIBILITY OF SUCH DAMAGES.
4. The Licensor is under no obligation to respond to any technical questions or inquiries, or provide any other user support in connection with the installation, use or the Reproduction and Other Exploitation of the Licensed Program or Derived Programs thereof.

Article 4 (Termination of Agreement)

1. The term of this Agreement shall begin from the time of receipt of the Licensed Program by the Recipient and shall continue as long as the Recipient retains any such Licensed Program in any way.
2. Notwithstanding the provision set forth in the preceding Paragraph, in the event of the breach of any of the provisions set forth in this Agreement by the Recipient, this Agreement shall automatically terminate without any notice. In the case of such termination, the Recipient may not use or conduct Reproduction and Other Exploitation of the Licensed Program or a Derived Program: provided that such termination shall not affect any rights of any other Recipient receiving the Licensed Program or the Derived Program from such Recipient who breached this Agreement.

Article 5 (Governing Law)

1. IPA may publish revised and/or new versions of this License. In such an event, the Recipient may select either this Agreement or any subsequent version of the Agreement in using, conducting the Reproduction and Other Exploitation of, or Redistributing the Licensed Program or a Derived Program. Other matters not specified above shall be subject to the Copyright Law of Japan and other related laws and regulations of Japan.
2. This Agreement shall be construed under the laws of Japan.

When calling please have ready the following information about your unit:

- Machine type: KR-1
- Manufacturing No. (Shown on the rating plate on the right side of the base.)
- Period of Usage (Please give us the date of purchase).
- Description of Problem (as detailed as possible).

AUTO KERATO-REFRACTOMETER KR-1

USER MANUAL
Version of 2011 (2011.07-100LW0)
Date of issue: 1st, July 2011

Published by TOPCON CORPORATION

75-1 Hasunuma-cho, Itabashi-ku, Tokyo, 174-8580 Japan.

AUTO KERATO-REFRACTOMETER

KR-1

TOPCON MEDICAL SYSTEMS, INC.

111 Bauer Drive, Oakland, NJ 07436, USA Phone:+1-201-599-5100 Fax:+1-201-599-5250 www.topconmedical.com

TOPCON CANADA INC.

110 Provencher Avenue, Boisbriand, QC J7G 1N1 CANADA Phone:+1-450-430-7771 Fax:+1-450-430-6457 www.topcon.ca

TOPCON EUROPE MEDICAL B.V.

(European Representative)(European Sole Sales Company)

Essebaan 11; 2908 LJ Capelle a/d IJssel; P.O.Box145; 2900 AC Capelle a/d IJssel; THE NETHERLANDS

Phone:+31 -(0)10-4585077 Fax:+31 -(0)10-4585045 E-mail: medical@topcon.nl; www.topcon.eu

ITALY OFFICE

:Viale dell' Industria 60; 20037 Paderno Dugnano; (Milano), ITALY Phone:+39-02-9186671 Fax:+39-02-91081091 E-mail: topconitaly@tiscali.it; www.topcon.it

DANMARK OFFICE

:Praestemarksvej 25; 4000 Roskilde, DANMARK Phone:+45-46-327500 Fax:+45-46-327555 E-mail: topcon@topcondanmark.dk www.topcondanmark.dk

IRELAND OFFICE

:Unit 276, Blanchardstown; Corporate Park 2 Ballycoolin Dublin 15, IRELAND Phone:+353-18975900 Fax:+353-18293915 E-mail: medical@topcon.ie; www.topcon.ie

TOPCON DEUTSCHLAND G.m.b.H.

Hanns-Martin-Schleyer Strasse 41; D-47877 Willich, GERMANY Phone:+49-(0)2154-8850 Fax:+49-(0)2154-885177 E-mail:med@topcon.de; www.topcon.de

TOPCON ESPAÑA S.A.

HEAD OFFICE:Frederic Mompou 4 Esc. A Bajos 3, 08960 Sant Just Desvern Barcelona, Spain Phone:+34-93-4734057 Fax:+34-93-4733932 E-mail: medica@topcon.es; www.topcon.es

PORTUGAL OFFICE:Rua da Forte,6-6A,L-0.22,2790-072 Carnaxide, PORTUGAL Phone:+351-210-994626 Fax:+351-210-938786 www.topcon.pt

TOPCON S.A.R.L.

89, rue de Paris 92585 Clichy, FRANCE Phone:+33-(0)1-41069494 Fax:+33-(0)1-47390251 E-mail:topcon@topcon.fr; www.topcon.fr

TOPCON SCANDINAVIA A.B.

Neogatan 2; P.O.Box 25; 43151 Mölndal, SWEDEN Phone:+46-(0)31-7109200 Fax:+46-(0)31-7109249 E-mail:medical@topcon.se; www.topcon.se

TOPCON (GREAT BRITAIN) LTD.

Topcon House,Kennet Side,Bone Lane,Newbury,Berkshire RG14 5PX United Kingdom

Phone:+44-(0)1635-551120 Fax:+44-(0)1635-551170 E-mail: info@topcon.co.uk; www.topcon.co.uk

TOPCON POLSKA Sp. z o. o.

ul. Warszawska 23; 42-470 Siewierz, POLAND Phone:+48-(0)32-6705045 Fax:+48-(0)32-6713405 www.topcon-polska.pl

TOPCON SINGAPORE MEDICAL PTE. LTD.

60 Alexandra Terrace, #08-27 The Comtech, SINGAPORE 118502 Phone:+65-68720606 Fax:+65-67736150 www.topcon.com.sg

TOPCON INSTRUMENTS (MALAYSIA) SDN.BHD.

No. D1, (Ground Floor), Jalan Excella 2, Off Jalan Ampang Putra, Taman Ampang Hilir, 55100 Kuala Lumpur, MALAYSIA Phone:+60-(0)3-42709866 Fax:+60-(0)3-42709766

TOPCON INSTRUMENTS (THAILAND) CO.,LTD.

77/162 Sinnsathorn Tower, 37th Floor, Krungthonburi Rd., Klongtongsai, Klongsarn, Bangkok 10600, THAILAND Phone:+66(0)2-440-1152~7 Fax:+66-(0)2-440-1158

TOPCON CORPORATION BEIJING OFFICE

Block No.9, Kangding Street, Beijing Economic-Technological Development Area, Beijing,100176, CHINA Phone:+86-(0)10-6780-2799 Fax:+86-(0)10-6780-2790

TOPCON CORPORATION SHANGHAI OFFICE

14L Huamin Empire Plaza, No.726, Yan-an Xi Road, Shanghai, 200050, CHINA Phone:+86-(0)21-5238-7722 Fax:+86-(0)21-5237-0761

TOPCON CORPORATION BEIRUT OFFICE

P.O.Box 70-1002 Antelias,Beirut, LEBANON Phone:+961-4-523525/523526 Fax:+961-4-521119

TOPCON CORPORATION DUBAI OFFICE

P.O.Box 293705, Dubai Airport Free Zone L.L.U J-12, Dubai, U.A.E. Phone:+971-4-299-5900 Fax:+971-4-299-5901

TOPCON CORPORATION

75-1 Hasunuma-cho,Itabashi-ku,Tokyo,174-8580 Japan.

Phone:3-3558-2520 Fax:3-3960-4214 www.topcon.co.jp